



CORVAIR OWNERS **GUIDE** **1965**

A WORD FROM CHEVROLET . . .

This Owners Guide contains important information regarding the operation and maintenance of your Corvair.

In order to obtain maximum enjoyment and usage from your car, we suggest that you familiarize yourself with the contents of this booklet and follow the recommendations outlined.

Your Chevrolet dealer has the trained personnel and specialized equipment to properly service your Corvair. Have him inspect your car and perform any maintenance or adjustments required.

We would like to take this opportunity to thank you for choosing a Chevrolet product—and assure you of our continuing interest in your motoring pleasure and satisfaction.

CHEVROLET MOTOR DIVISION • GENERAL MOTORS CORPORATION
DETROIT, MICHIGAN 48202

TABLE OF CONTENTS

	<i>Page</i>
Corvair	
Operating Instructions	2
Instruments	8
Controls	10
Corvair Corsa	22
Corvair Greenbrier	24
Cleaning Hints	30
Maintenance and Lubrication	32
Specifications	44
Service Accessories	46
Minor Trouble Shooting Guide	47
Minor Trouble Shooting Procedures	48
Index	51
Owner Protection Plan	Inside Back Cover

All information contained in this booklet is based on the latest product information available at the time of printing. The right is reserved to make changes at any time without notice.

OPERATING INSTRUCTIONS

YOUR CORVAIR'S FIRST FEW HUNDRED MILES OF DRIVING

Sound design and precision manufacturing methods will permit you to operate your new Corvaire without adhering to a formal "break-in" schedule. However, during the first few hundred miles of driving you can, by observing a few simple precautions, add to the future performance and economy of your car.

It is recommended that your speed during the first 500 miles be confined to a maximum of 60 MPH, but do not drive for extended periods at any one constant speed, either fast or slow. During this period, avoid full

throttle starts and unnecessary, quick abrupt stops.

Gentle braking during the first few hundred miles of operation will result in longer brake life and better future performance. Avoid unnecessary, hard stops especially during the first 200 miles of operation since brake misuse during this period will destroy much future brake efficiency.

Always drive at a moderate speed until the engine has completely warmed up.

DRIVING FOR ECONOMY

Proper maintenance and wise operation will combine to help you achieve maximum fuel economy with your Corvaire. Your Authorized Chevrolet Dealer can properly tune and maintain your car but wise operation is your responsibility. Give the car sufficient warm-up

time, do not make "Full Throttle" starts or unnecessary skidding stops, and drive at reasonable speeds and as steady as traffic permits to gain the benefits of all the economy built into your Corvaire.

CAUTION: Carbon monoxide is a poisonous gas produced by the engine of any car. It is odorless, so you cannot detect its presence. Be safe. Never start or run engine in a closed garage, and do not sit in a parked car with engine running unless windows are open.

STARTING THE ENGINE

IGNITION SWITCH

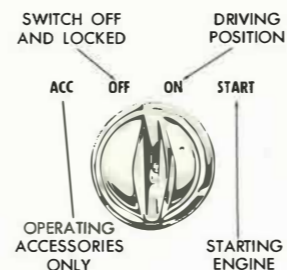

START—Used only when starting engine. When released, switch returns to ON.

ON—For normal operation after engine has been started.

OFF—Turns off engine and accessories.

ACC—All accessories routed through the ignition switch may be operated with the switch in this position.

Engine will not start with switch in ACC position—ignition system is by-passed, permitting battery power to flow directly to accessories.

To prevent rapid discharge of battery, do not operate accessories for prolonged periods with switch in ACC position.

STARTING

1. **POWERGLIDE**—Place control lever in N position. The engine will not start with the transmission in gear.

MANUAL TRANSMISSION—Place gearshift control lever in neutral, and depress clutch pedal to the floor.

2. Depress accelerator pedal part way and hold. In extreme cold weather (0°F. and below), depress accelerator pedal twice, then hold pedal part way down during starting.

NOTE: Engine will not start with accelerator pedal depressed to floor, except when "flooded."

3. Turn ignition switch to START and release as soon as engine starts.

4. "FLOODED" ENGINE—Depress accelerator pedal to floor and hold while cranking engine. DO NOT "PUMP" ACCELERATOR PEDAL WHEN ENGINE IS "FLOODED."

WARM-UP

Never race engine or drive at high speeds until engine has had a chance to warm up. Driving with moderate accelerator pedal application will prevent stalling and hesitation, especially during cold weather. Failure to allow sufficient warm up time can cause unnecessary wear to engine, axle or transmission parts because of inadequate lubrication.

DRIVING WITH THE MANUAL TRANSMISSIONS

The three-speed and optional four-speed transmissions are operated in basically the same manner. Shift patterns differ, of course, as illustrated in the two illustrations on page 5.

1st GEAR (LOW)—Depress clutch pedal, shift into 1st gear, slowly release clutch pedal while pressing on accelerator. As car gains speed, depress clutch pedal, release accelerator and move gearshift into 2nd gear.

2nd GEAR—Release clutch pedal and depress accelerator as above as car gains speed, then, in same manner

as before, move gearshift lever into 3rd gear.

3rd GEAR (HIGH)—Slowly release clutch pedal and depress accelerator pedal. This is the cruising gear for all normal driving with the 3-speed transmission. With the 4-speed transmission 3rd gear will provide more response and higher performance for driving in heavy traffic.

4th GEAR (HIGH—4-speed transmission only)
Shift into 4th gear in the same manner for normal cruising with the 4-speed transmission.

NOTE: *Whenever the vehicle begins to labor in any gear, depress the clutch pedal and shift to the next lower gear.*

TO STOP—Release the accelerator and depress the brake pedal. As car slows down, depress the clutch pedal and move the gearshift lever into neutral.

NEUTRAL—For use when starting or idling engine.

REVERSE—Operate as for 1st gear but always at a slow speed.

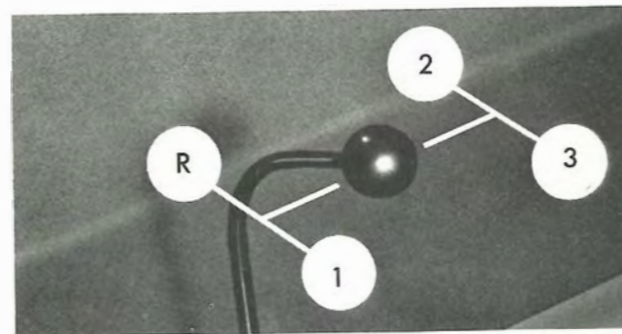

Three Speed Shift Pattern

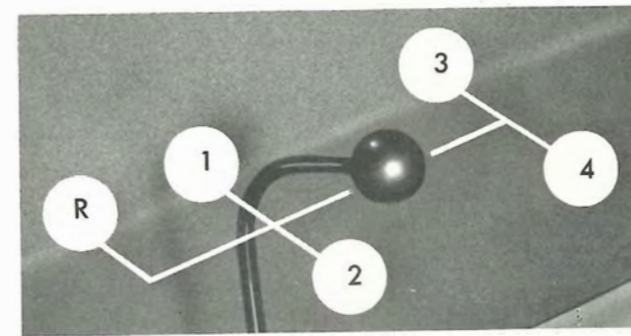

Four Speed Shift Pattern

PUSHING TO START

- Turn on key and depress clutch pedal.
- Place gearshift lever in neutral position until car speed reaches approximately 15 mph.

DRIVING WITH THE POWERGLIDE TRANSMISSION

The optional Powerglide transmission is a completely automatic transmission which replaces the standard clutch and transmission. After starting the engine with the selector lever in N (neutral) position, merely select the range desired and depress the accelerator. The Powerglide transmission will do the rest.

- Move shift lever to 3rd position and slowly release clutch pedal.
- Never attempt to start the car by towing.

more economical cruising gear in the shortest possible time. Hard acceleration for fast starts will cause the transmission to remain in low gear for a considerably longer period.

When driving at speeds below 45 mph, the transmission may be shifted back into low range for extra acceleration for passing by depressing the accelerator pedal fully. The transmission will automatically shift back into

cruising gear when the accelerator pedal is momentarily released.

PUSHING TO START

- Turn off all electrical loads such as radio, heater and, if possible, lights until the engine starts.
- Turn on key and move selector lever to neutral. At 20 to 25 mph move lever to L.
- When engine starts, move selector lever to D.

NOTE: Never tow to start.

OPERATING YOUR POWERGLIDE TRANSMISSION

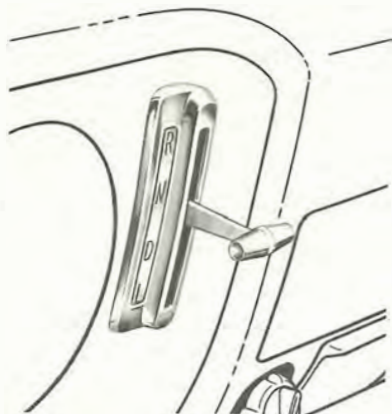

POSITION	OPERATION	USES
R —REVERSE	For Backing Car (From Stopped Position)	NORMAL DRIVING RANGE
N —NEUTRAL	For Starting Engine (Brakes Applied)	
D —DRIVE	For all Forward Driving. Step hard on accelerator for extra acceleration below 45 mph.	
L —LOW	For Hard Pulling at Low Speeds, Climbing, or Descending Steep Grades and for additional engine braking below 40 mph.	SAND, SNOW, MUD OR ON STEEP GRADES

TOWING

- Place selector lever in neutral.
- If transmission or axle are malfunctioning, tow with rear wheels raised.
- When towing any vehicle on its front wheels, the steering wheel should be secured to maintain a straight forward position.
- Never tow faster than 50 mph.

ROCKING CAR

When stuck in mud, sand or snow, you may rock the car by depressing the accelerator slightly and shifting the selector lever between R and D. Avoid excessive engine speed while performing this operation.

PARKING CAR

It is important that when your Corvair is parked the parking brake be fully engaged. Do not count on the

DRIVING WITH POSITRACTION REAR AXLE

The Positraction rear axle gives you constant driving force on both rear wheels; especially helpful in the winter and during other slippery driving conditions. In normal use, light throttle application will supply

transmission to hold the car. Always engage the parking brake when parked.

POWERGLIDE DRIVING CAUTIONS

- Always engage parking brake when parked.
- Do not accelerate engine in L, D, or R with the brakes engaged. This can cause damage by overheating transmission.
- Do not hold car on an upgrade by accelerating engine. Use brakes.
- Use low position for hard pulls at low speed, climbing or descending steep grades and for push starting.
- Always stop car before shifting to reverse.

INSTRUMENTS

All driving instruments are grouped in the instrument cluster which is located immediately in front of the driver to provide quick reading and maximum convenience and accessibility. The TEMP-PRESS and GEN-FAN indicators provide important information concerning the condition of the engine and should be observed regularly during operation of the car. The information on these pages will help you understand the operation of these instruments. The illustrations here and on page 10 will acquaint you with the instrument cluster and the instrument panel as a whole.

FUEL GAUGE



This electrically operated gauge accurately indicates the amount of fuel in the fuel tank only when the ignition switch is in the ON position. When the ignition is "off", the indicator pointer will not necessarily return to the empty (E) mark, but may stop

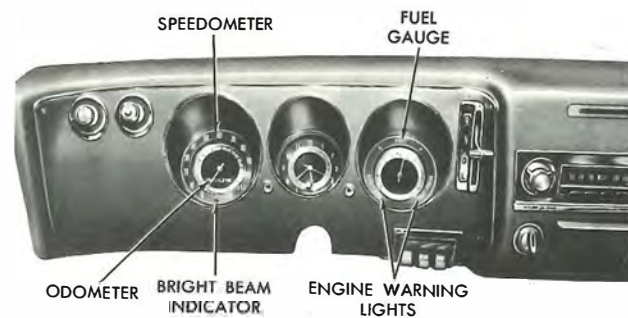

at any point on the gauge. Therefore, always be sure that the ignition switch is "on" when reading the fuel gauge.

SPEEDOMETER

Conveniently located in the instrument cluster directly ahead of the driver, the speedometer shows at a glance the speed of the car in miles per hour. The odometer, encircled within the speedometer dial, registers accumulated vehicle mileage.

TEMP-PRESS AND GEN-FAN INDICATORS

These indicators provide a check on the operating condition of the engine and the generator. Both indicators should light with the ignition switch ON before starting the engine and should go out after the engine is started. The lights should remain out while engine is operating, except the GEN-FAN indicator may flicker when engine is idling.

CAUTION: If either of these indicators light while car is being driven, immediately follow the procedure outlined under "EMERGENCY OPERATING INSTRUCTIONS," so car may be driven to the nearest service facility.

EMERGENCY OPERATING INSTRUCTIONS



(To be followed if either TEMP-PRESS or GEN-FAN indicators light while car is being driven.)

1. Set heater FAN and HEAT controls to full "ON" positions. (If equipped with air conditioning, turn air conditioning COOL switch to OFF.)

NOTE: After setting the heater controls, leave them in that position until cause of trouble is corrected.

2. Stop the car as soon as driving conditions permit. Turn ignition key to OFF to stop engine but turn key back to ON so heater blower will continue to cool engine.
3. Check for broken fan belt or belt off pulleys or engine low oil level. If only GEN-FAN indicator is lighted, belt is not broken or off pulleys and engine oil level is satisfactory, car can be driven at slow speeds; however, generator must be checked and serviced as soon as possible.
4. If trouble is found to be a broken fan belt or belt off pulleys, wait approximately five minutes, start engine and drive car at no more than 25 miles per hour until TEMP-PRESS indicator comes on, then repeat Step 2.

NOTE: The GEN-FAN indicator will stay on until fan belt is installed.

5. Repeat Step 4 as necessary until facility is reached where fan belt can be installed.

INSTRUMENTS AND CONTROLS

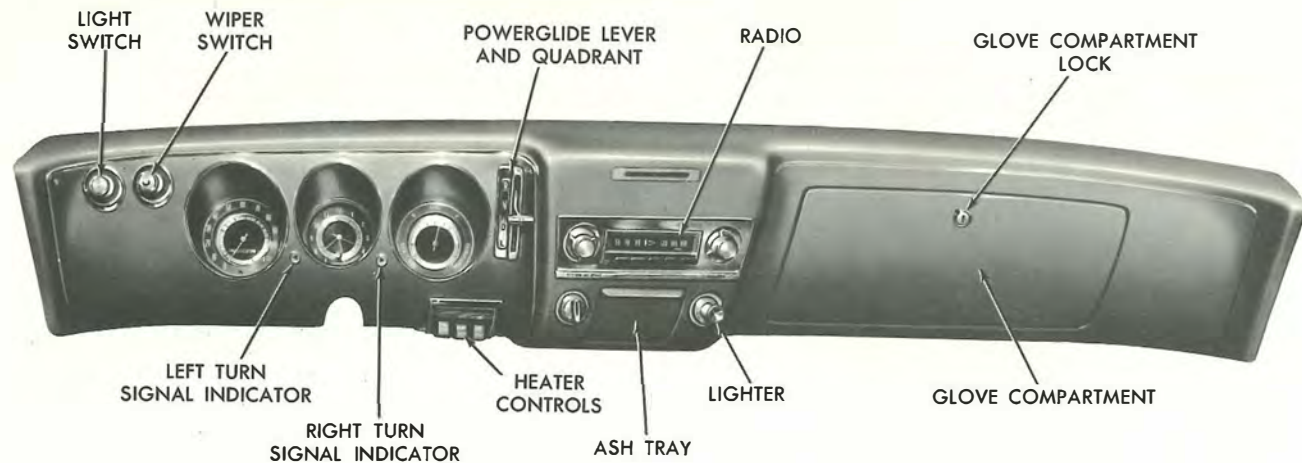

LIGHT CONTROL KNOB

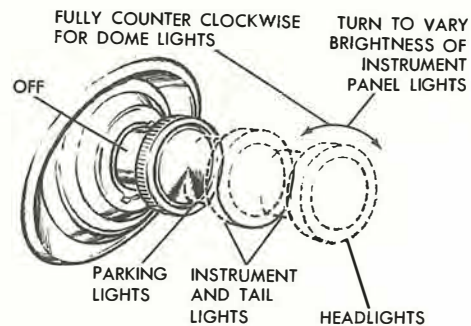

The three-position light switch is operated as shown. Turn the knob to vary the brightness of the instrument lights. Turn the knob fully counterclockwise past the "detent" to turn on the dome light. The headlamp and parking lamp circuits are protected by a circuit breaker. An overload condition will cause the headlights to "flicker" on and off. If this flickering condition is experienced, the head lamp circuit should be checked by your Authorized Chevrolet Dealer.

DIMMER SWITCH



The foot button switches the headlights between "high" and "low" beam. The red "high" beam indicator will be lighted when the headlights are on "high" beam. Always dim the lights when approaching oncoming cars.

TURN SIGNAL

The turn signal lever should be moved UP to signal a right turn or DOWN to signal a left turn. The green turn signal indicators in the instrument panel will signal the direction as will the front and rear turn signal lamps. When the turn is completed, the lever will automatically return to neutral position.

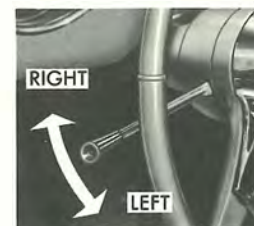

Get into the habit of turning on the signal well in advance of where you plan to turn, other drivers will appreciate your consideration.

LIGHTING SYSTEM TROUBLE CHECKS

- If headlights flicker, your Authorized Chevrolet Dealer should be called upon immediately to correct the overload condition.
- If the tail light fuse blows out, the instrument panel lights will also be inoperative. Check both the instrument panel fuse and the tail light fuse. (See Specifications.)
- If, when signalling a turn, the green turn signal indicator comes on but does not flash, a burned out front or rear turn signal lamp on that side or an im-

proper flasher (3-bulb instead of 2-bulb flasher) is indicated.

- If the green turn signal indicator comes on and stays on but does not flash when signalling a turn in either direction, and no "clicking" is heard, replace the flasher.
- If flasher clicks but the green turn signal indicator does not operate, replace the indicator bulb.
- A series-type, 2-bulb flasher is standard equipment on Corvairs. Always replace with the same type flasher.

FOOT CONTROLS

Foot controls consist of the dimmer switch (the operation of which is covered on page 11), the clutch pedal (manual transmissions only), the brake pedal and the accelerator pedal.

CLUTCH PEDAL

The operation of the clutch pedal has been fully covered under "Driving with the Manual Transmissions" on page 4. Its operation is the same whether your car is equipped with the 3-speed or the 4-speed transmission. Excessive clutch wear can be caused by letting up the clutch abruptly rather than smoothly, and by "riding" the clutch—that is, letting your foot rest on the clutch pedal while driving.

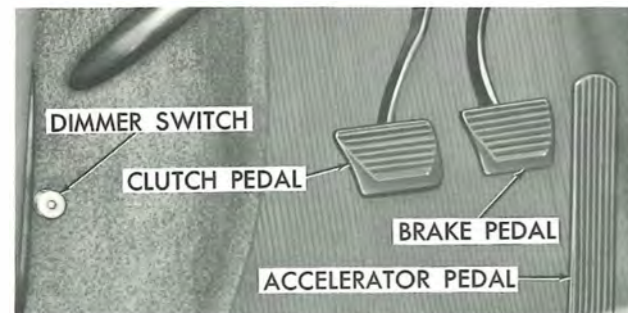

CLUTCH ADJUSTMENT

Clutch adjustment should be checked and adjusted periodically as necessary to compensate for clutch facing wear. To check, depress pedal by hand until resistance is felt. Free travel of pedal should be approximately $\frac{3}{4}$ -inch; if very little or no free play is evident, clutch adjustment is required.

BRAKES

The self adjusting brakes usually adjust themselves as necessary. Should brake pedal travel become excessive, drive the car forward and backward several times applying the brakes to stop after backing. Pedal travel should return to normal after several reverse stops.

The brake pedal should have a hard firm feel when applied. If pedal feel becomes soft or spongy the brakes are in need of service.

Pull the parking brake lever to engage the brake. The lever will remain in the applied position until released. To release, pull the handle toward the steering wheel, depress the "trigger" and allow the handle to return to the released position. Always engage the parking brake when parked.

WINDSHIELD WIPERS AND WASHERS



The single-speed (or optional two-speed) parallel acting wipers are operated by means of the wiper control knob on the dash. Turning this knob clockwise turns on the wiper motor. The optional two-speed wipers have three switch positions, "Off," "Low" and "High." A fully counterclockwise turn of the knob turns off the wiper.

Exposure to the "elements" tends to "wear out" the rubber in the wiper blades. Check the blades periodically and replace them whenever they show signs of streaky or otherwise poor wiping action.

Pressing once on the accessory windshield washer button will cause the washer to squirt a measured amount of water or other cleaning agent onto the glass and will at the same time turn on the wiper. The wiper must then be manually turned off, when the washing process

is completed, by means of the wiper control knob.

Water or cleaning agent needed for operation of the accessory windshield washers is carried in a plastic water jar attached to the dash panel within the luggage compartment. Keep the washer jar filled to a level 2 inches below the top of the jar with a suitable solvent. Windshield Washer Anti-Freeze and Solvent, G. M. Part No. 1050001, is recommended for use in the Corvair windshield washer jar. In the winter, fill the washer jar only $\frac{3}{4}$ full to allow for expansion if the solution freezes. In freezing weather, pre-warm the windshield using the heater defrosters before using the washers.

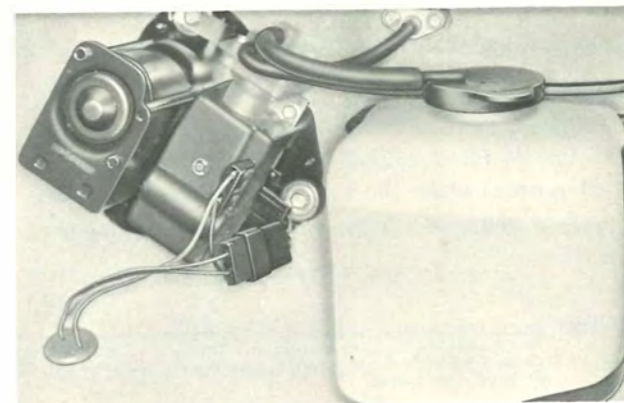

DIRECT AIR HEATER



The Direct Air Heater uses engine cooling air to heat the interior of the car. Operation of the controls is given below.

FAN—Controls blower speed. Blower must not be operated unless HEAT lever is depressed.

HEAT—Controls the amount of hot air to the system.

NOTE: When shutting off the above control lever, pull fully up until the lever snaps into the latch position.

DEF—Diverts heated air to the defroster outlets.

OPERATION FOR MAXIMUM COMFORT

- **MINIMUM HEAT REQUIREMENTS**—During spring and fall in areas where climatic conditions are less severe, depress the HEAT lever *only* as required for your comfort.

NOTE: In Direct Air Heaters vapor may collect when vehicle stands for long periods, keep the HEAT lever in OFF position for the first few minutes of engine operation. This will reduce the tendency for moisture to condense on windshield. Oil spilled on engine shrouding may cause odor in passenger compartment. To avoid discomfort, the cause of any odor should be traced and defect promptly corrected.

- **MAXIMUM HEAT REQUIREMENTS**—Depress HEAT lever to extreme down position. If heat becomes excessive, pull up HEAT knob to desired position.

Additional rear seat compartment heat may be obtained by opening the heater outlet located in the seat riser.



Heater Operating Tips

The Direct Air Heater receives air from the air inlet louvers below the rear window. Clean snow from this opening and surrounding areas before operating the heater.

Operate the heater for several minutes before turning on the defroster. This will clear the system of moisture and help prevent windshield fogging.

Keep all windows and vents closed to reduce drafts, and noise.

Quicker defrosting may be obtained when the rear seat heater outlets are closed.

AIR CONDITIONING

The optional air conditioner provides controlled conditioned air at each of the three dash panel mounted outlets.

Air conditioner and heater are two separate units with a common control housing—The air condition controls function as follows.



COOL—Depress the COOL lever as required to provide the desired conditioned air temperature through the dash outlets. COOL lever must be depressed past detent before cooling fan will operate.

FAN—Vary the fan switch as necessary to satisfy comfort requirements. The FAN switch must be turned ON to at least "LOW" speed during all cooling operations.

AIR—For maximum cooling capacity during periods of extreme heat and humidity, and when first turning on the system, the air lever should be in the full "UP" position. Depress lever to satisfy needs under less severe cooling requirements.



AIR CONDITIONER OPERATING TIPS

Always operate the Air Conditioning System with all windows and vents closed to eliminate drafts, wind and road noise. The cover plate furnished should remain installed over the engine air recirculating slot during the season when cooling is required. This plate should be removed, and stowed as shown, when outside temperatures are continuously below 60°F.

For the best system operation at altitudes over 4000 ft., reduce the cooling output slightly.

Run the system for five minutes every week to lubricate seals and moving parts.

CHEVROLET "ALL TRANSISTOR" RADIOS

To operate the radios, the ignition switch must be in "ON" or "ACC" position.



Antenna

For best FM operation the antenna must be extended to a length of 31 inches. For best AM operation the antenna should be fully extended.



● ● ● AM Radios

The left hand control knob is the "on-off" switch and volume control. At its base is the tone control wing knob. The right hand knob is the manual station selector. With the optional rear seat speaker, a wing knob at the base of the station selector knob allows use of front, rear or both speakers.

Five push buttons allow station selection in the Push Button Radio. To preset, pull the push button "out" as far as it will go, tune in the desired station manually and then push the button fully "in." Repeat for each push button.

● ● ● AM/FM Radio

This set receives clear static-free FM broadcasts as well as standard AM programs. Move the slide bar to select AM or FM reception. Controls are the same as in Manual and Push Button radios. FM broadcasts may be received as far as 60 miles from the sending station, depending on the power of the station and existing terrain. Push buttons may be set for AM, FM or both.

● ● ● Stereo Multiplex Adapter

The optional Stereo Multiplex Adapter permits FM Stereo reception with the AM/FM radio. Radio controls are used to turn the set on and off and for station selection. Controls on the adapter are Volume, Tone and Balance (to balance the front and rear speakers). For a pleasing stereo effect the front speaker reproduces one channel and the rear speaker reproduces the other channel. The indicator light on the adapter will be lighted when the radio is tuned to an FM stereo station. Most broadcasts on such stations will be in stereo.

TELESCOPING STEERING COLUMN



The optionally available telescoping steering column permits positioning of the steering wheel for improved visibility and comfort. An axial adjustment of approximately three inches is provided for in the telescoping steering shaft.

Repositioning of the steering wheel can be accomplished at the driver's discretion. Turn the control knob counterclockwise to unlock—position wheel as desired—turn control knob clockwise to lock.



CIGARETTE LIGHTER AND ASH TRAY

The ash tray and cover is an integral unit. Press on lower position of cover to pivot receptacle toward you. To remove tray for cleaning purposes, press the catch at inside rear of tray and lift from panel.

Press on the optional cigarette lighter to heat. When ready for use, it will "pop" out.

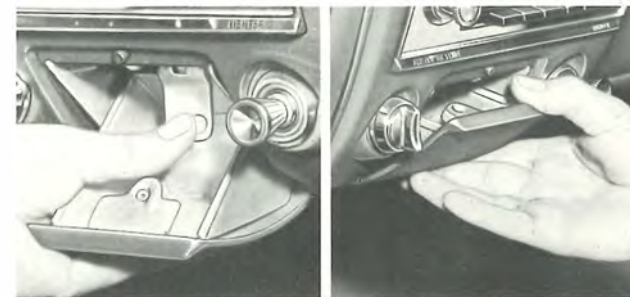

AIR VENTS

Additional summer ventilation is provided through vent inlets in each side of the front passenger compartment. The vents may be opened or closed by means of the control knobs located in the trim pad.



KEYS

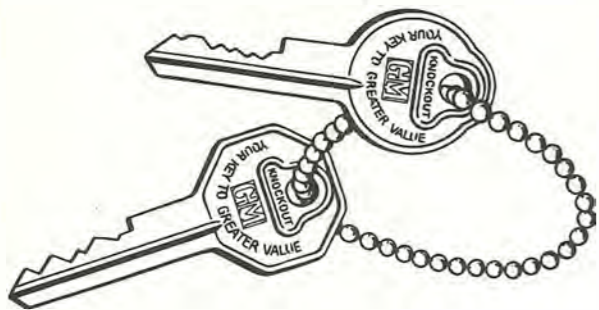

The octagonal-end key operates the ignition switch and the front doors of your Corvair.

The round-end key operates the glove box and luggage compartment. The optional spare tire lock requires its own key.

Each key has a serial number stamped on a removable plug. This number will provide necessary information to enable you to have another key made in the event that the original is lost.

To avoid the possibility that unauthorized persons might duplicate your key, it is strongly recommended that you record the serial number and then, with a hammer and punch, remove the knockout plug.

DOORS AND LOCKS

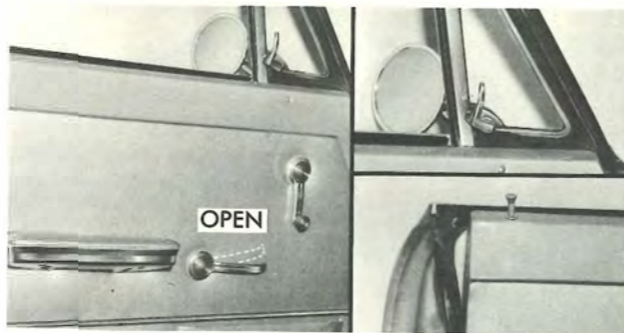

- To lock each door from the outside, depress the inside locking button, hold the outside door handle opening button fully down and firmly close the door. Lock doors from inside by depressing the locking buttons located on the window sills.
- Unlock the doors from outside by means of the ignition key (front only) or from inside by lifting up on the inside locking button.
- The front doors, whether locked or unlocked, may be opened from inside by lifting the inside door release handle.
- Open the ventipane windows by lifting up and forward on the friction locks. Pushed out, the window will remain in the desired position.

REAR DOORS

- Rear doors, on 4-door models are operated from the outside by means of a push button door handle in the same manner as the front doors. No key lock is provided on the outside of either rear door.
- The inside release handle pulls to the rear to open the rear doors in the same manner as the front doors.
- Lock the rear doors from inside by depressing the locking button in the window sill. When this button is depressed, both the inside and outside door handles are inoperative. This button must be raised before the doors can be opened either from the inside or outside. This feature becomes very important when young children ride in the rear seat.

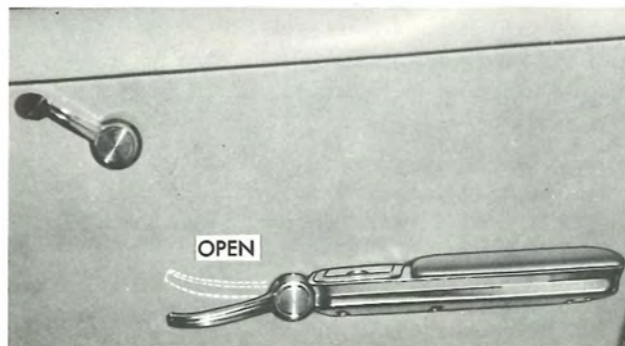

SEATS

Front Seat Adjustment

The one-piece front seat is easily adjusted forward or rearward to provide maximum driving comfort.

To adjust the seat, move the control lever on the driver's end of the seat rearward. Then by exerting slight body pressure the seat may be moved forward or rearward. When the lever is released, the seat is automatically locked in position.

The bucket seats are adjusted in exactly the same manner. The seat control lever for each seat is located beneath the outer edge of the seat (toward the door).

Seat Belts

Fasten the seat belts by pushing the metal catch into the buckle until it "snaps" into place. Tighten the belt until comfortably snug by pulling the end extending from the buckle. *Do not wear belt loosely.* Loosen by turning the entire buckle outward. Lift the buckle lever to unlatch and release the belt. *Never buckle an individual seat belt around more than one person.*

With bucket seats, the inner belt half is anchored behind the opposite seat.

Clean the belts, without removing them from the car, with a stiff bristle brush using a detergent recommended for nylon. *Never bleach or redye seat belts.*

It is recommended that the optional Chevrolet seat belt retractors be used on the outboard belt half only. When buckling the belt, be sure that it is fully extended

so there is no webbing wound around the retractor drum. Then adjust for proper fit at the buckle.

Folding Rear Seat

The folding rear seatback, standard equipment on Monza and Corsa, optional on all other Corvair models except convertible, quickly and easily folds forward and down to provide additional cargo space in four-door models as well as in coupe models. The folding seat in both models operates in exactly the same manner except that the four-door models include a folding panel at the bottom of the seatback which must be "snapped" into or out of place after lowering and before raising the seatback.

CAUTION: If the car has rear door armrests it will be necessary to open both rear doors before raising or lowering the rear seatback.

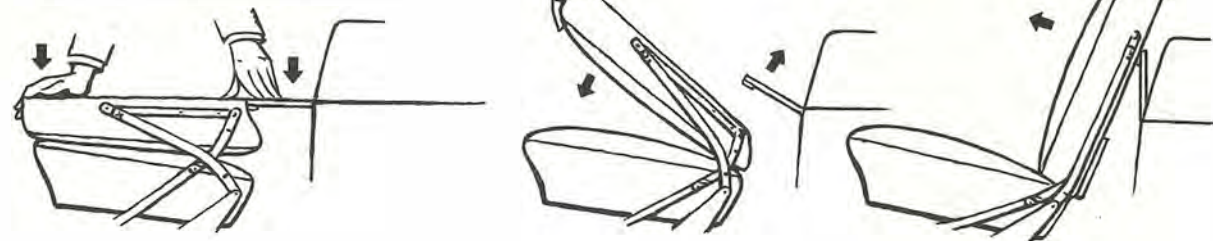

FOLDING REAR SEAT

To lower the folding seatback:

- Pull on each end of the seatback to unlock.
- Swing the seatback forward and down.
- On four-door models, press down on the front edge of the lowered seatback with one hand while "snapping" the folding panel, at the bottom of the seatback, into place.

To raise the seatback:

- On four-door models, press down on the front edge of the seatback and "unsnap" the folding panel.
- On all models, lift the seatback and slam firmly into place.

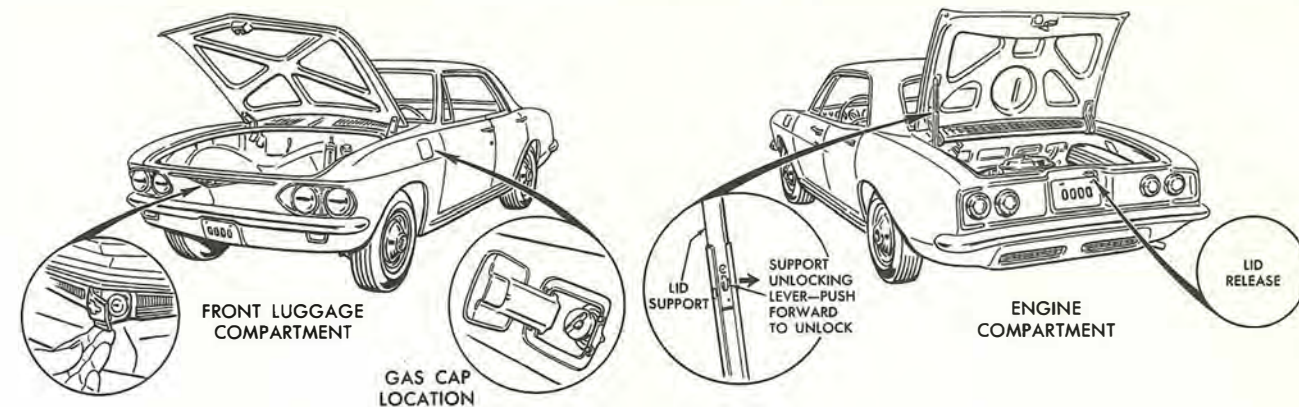

LUGGAGE COMPARTMENT

The luggage compartment is located beneath the lid at the front of the car.

- To open the luggage compartment, pivot the spring loaded emblem to reveal lock, insert the key and, holding the lid down to relieve the tension on the lock, turn the key fully clockwise and allow the counterbalance lid to open.
- To close, slam the lid firmly.

A second luggage space is located behind the rear seat, for parcels or luggage which would otherwise take up seat or floor space.

GAS CAP

The gas cap is concealed beneath the spring loaded door on the left front fender.

ENGINE COMPARTMENT

- To open: Push up the lid release while lifting the lid. Lift the lid all the way up, then release.
- To close: Lift up on lid, unlock the support arm catch lock, then lower the lid. Drop the lid the last six inches to assure that the lid lock mechanism is engaged.

For proper engine cooling keep the vents located below the rear window free of ice, snow and leaves.

CORVAIR CORSA

The Corvair Corsa models are operated and maintained as outlined for the regular Corvair. Additional instrumentation and operating instructions peculiar to Corsa models only are reviewed in the following pages.

A high-performance (140 hp Turbo-Air 164) engine is provided as the standard engine for Corsa models. The optionally available turbocharged engine is designed around the Turbo-Supercharger and all the related parts

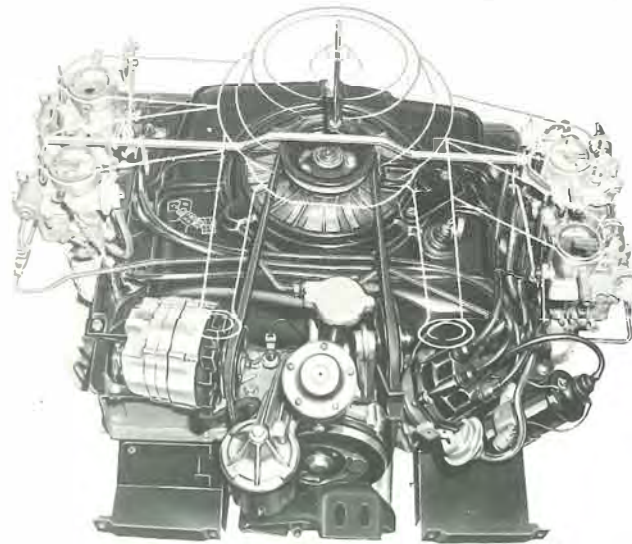

are necessary for proper performance. Under no conditions should the Turbo-Supercharger be removed and installed on another car not equipped with the proper engine.

Break-In Period—We recommend that the supercharger not be used for the first 500 miles. Keep engine speed below 2500 rpm to maintain negative readings on the Manifold Pressure Gauge. From 500 to 1000 miles, short bursts are permitted but not sustained runs. After the first 1000 miles, the car may be driven to take full advantage of the power from the supercharger.

Fuel and Engine Oil Requirements—Refer to "Maintenance and Lubrication."

Air Recirculating Plate—This plate, the same as used on Air Conditioned Corvairs, should be installed and removed as recommended on Page 15.

Detonation—Caused by low grade fuel, faulty timing, carbon deposits or an over-filled crankcase, this condition is more serious than on other engines. If detonation occurs have your car checked by your Chevrolet Dealer.

YOUR CORVAIR CORSA INSTRUMENT PANEL

We feel that you, as owner of the Corvair Corsa, will be more interested in a constant check on engine operation than would the average driver. Therefore the following instruments have been provided for your use and information.

Tachometer—with a range of 6000 rpm. Upshifts can be made up to 5300 rpm. Downshift as desired provided engine speed in new gear does not exceed 5300 rpm. The red line at 5500 rpm indicates maximum recommended engine speed.

Speedometer—maximum reading of 140 mph. Odometers are provided for both trip and cumulative mileage. Set the trip odometer by means of the knob located beneath the instrument panel and to the left of the steering column.

Temp-Press and Gen-Fan Indicators—operate in the same manner as on other Corvairs. In addition, a warning buzzer connected to the temperature light will operate if engine temperature reaches the danger point. Under extreme operating conditions, momentary engine overheating may occur. Should the Temp-Press light

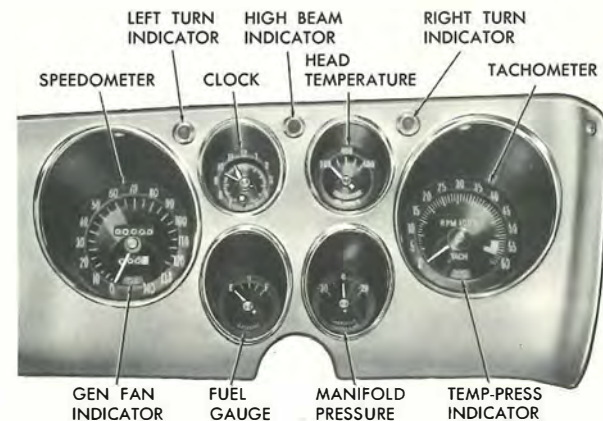

come on, release the throttle and, if the light stays on, follow the instructions presented on Page 9.

Manifold Pressure Gauge—tells when the supercharger is functioning. Positive readings indicate that the supercharger is building up pressure for more power. Negative readings indicate normally aspirated engine operation.

Cylinder Head Temperature Gauge—indicates cylinder head temperature to warn of approaching overheat condition.

CORVAIR GREENBRIER

INSTRUMENTS AND CONTROLS

The Corvaire Greenbrier instruments and controls are essentially the same as those of the Corvaire which are described in preceding pages of this book. However, due to body construction, various items differ somewhat in operation and location. The next few pages cover those items peculiar to the Corvaire Greenbrier only.

AIR VENTS

Additional outside air may be admitted into the vehicle through air inlets located on each side of the passenger compartment. The Air Control Lever must be in the down position to admit outside air to the inlets. Place the lever in the up position to eliminate flow of outside air to inlets.



GASOLINE HEATER



The optional Corvaire Greenbrier gasoline heater provides an ample volume of heated air within two minutes after being turned on; controls are:

FAN—This lever provides "LOW" blower speed at its first stop and "HI" blower speed when in the full down position; it must be pushed down to either position before heater will operate.

DEF—Diverts heated air to the defroster ducts for defogging or deicing windows; depress to increase flow.

HEAT—Depress lever to select degree of heat desired

NOTE: It is a normal condition for combustion blower to operate a short time after heater or car ignition is turned off.

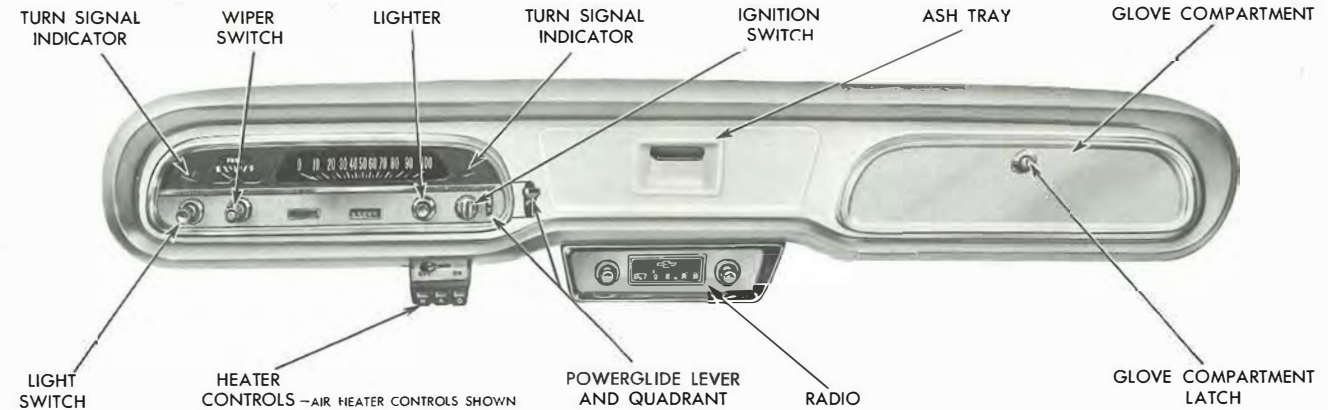

FOOT CONTROLS

Foot controls, illustrated below, are operated in the same manner as those of the Corvaire.

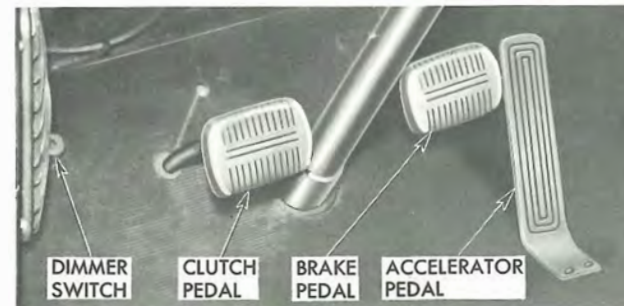

WINDSHIELD WASHERS

Water or cleaning agent needed for operation of the accessory windshield washers is carried in a plastic water bag under the dash panel, it is attached to the cowl by three hooks. To fill with water or solvent: remove the bag from the hooks, drop to where the cap may be unlocked and removed, fill the bag, replace the cap and reinstall on the three hooks. Never use any solvent or antifreeze solution which contains methanol.



ASH TRAY

The ash tray will pivot out when the handle is pulled.

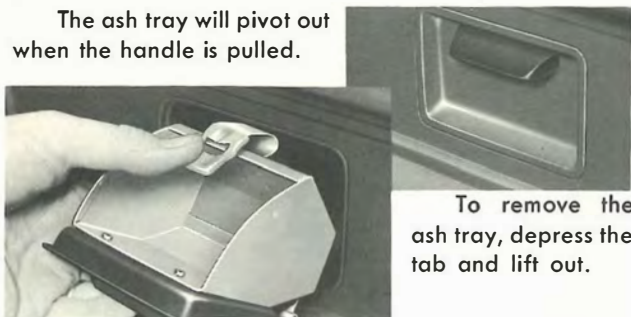

To remove the ash tray, depress the tab and lift out.

ENGINE COMPARTMENT ACCESS

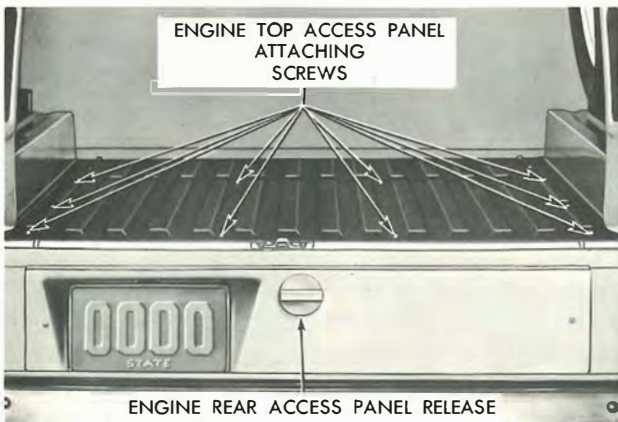

ENGINE TOP ACCESS PANEL ATTACHING SCREWS

ENGINE REAR ACCESS PANEL RELEASE

DOORS AND LOCKS



Both front doors may be locked from the outside by means of the ignition key inserted into the push button in the door handle. Turn the key clockwise to lock, counter-clockwise to unlock. Both doors may be key locked while open, and when closed, they will remain locked.

Lock the front doors from the inside by pushing fully forward on the release handles. Unlock and open the doors from the inside by pulling fully rearward on the release handles.

The ventipane window friction locks are simply lifted up and forward to unlock and the pane pushed out to the desired position.

DOUBLE SIDE DOORS

FRONT SIDE DOOR — Open from the outside by turning the handle downward and from the inside by pulling to the rear on the inside release handle.

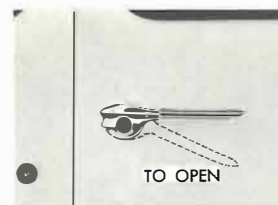

REAR SIDE DOOR—Open (after the front side has been opened) by means of the release handle located on the inner door panel.



LOCKING THE SIDE DOORS —After both side doors are closed, they may be locked from the inside by means of the push button located on the foremost part of the window sill. The lock is conveniently located for accessibility by the driver. Visual indication precludes the necessity of checking operation of the doors to see if they are locked.



DOUBLE REAR DOORS

The rear doors operate in much the same manner as the side doors, but lock and unlock at the door handle push button release only. No inner door locking mechanism is provided for the rear doors.



FULL DOOR OPENING FEATURE

Special door checks normally permit each side and rear door to open to a maximum of 95°. By removing these checks from their retaining slots in the doors, a full 180° opening of each of these doors is possible. When the doors are closed the check automatically enters its slot in the door thus setting the door for its normal 95° opening.

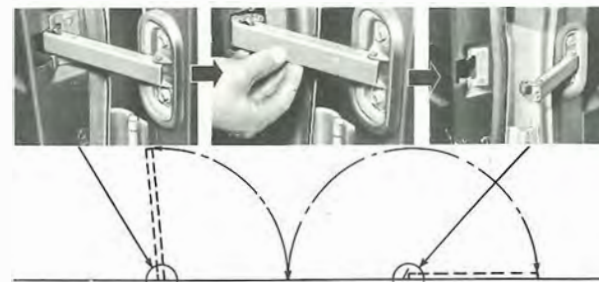

SEATS

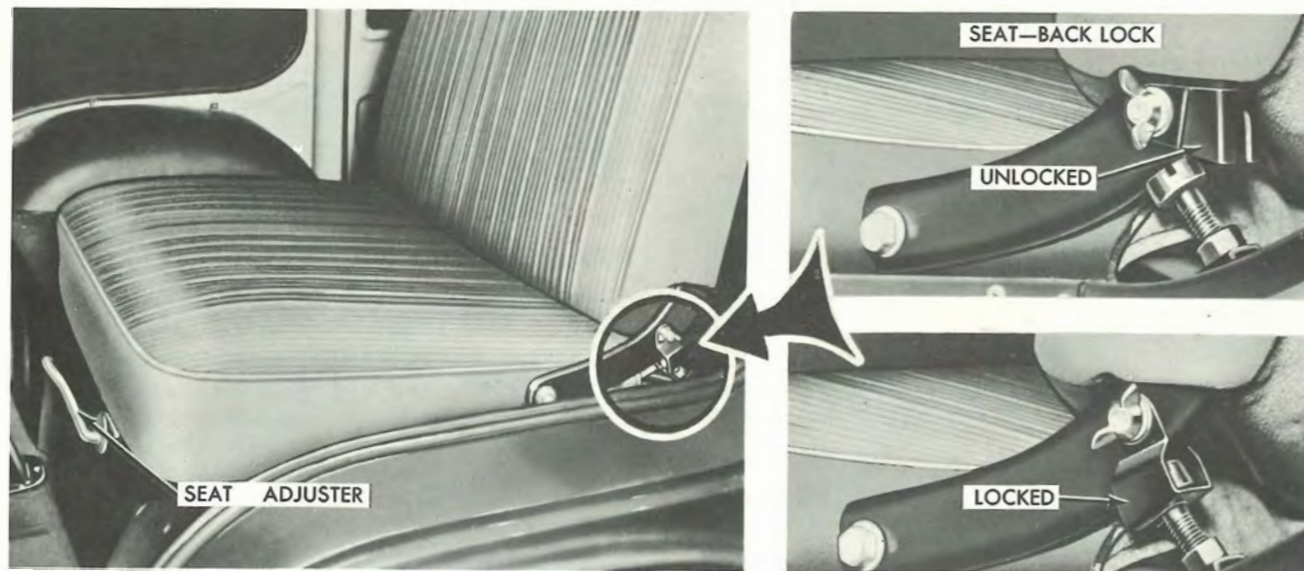

- Adjust the front seat fore and aft by means of the adjuster handle shown. Lift handle up to move seat.
- If desired, the seatback may be adjusted to lean farther forward or backward by means of the bolt and the lock nut shown.
- Adjustment of the seatback lock determines whether the seatback will be rigid or will fold forward. With the seatback lock in the down position, the seatback will not fold forward.

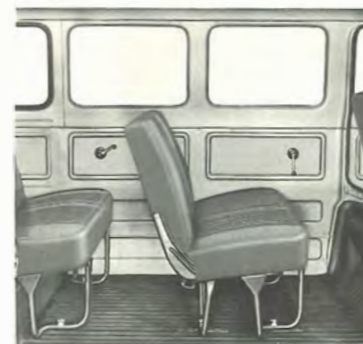

SECOND SEAT

The Greenbrier second seat assembly may be located in either a forward or backward seat position or in the third seat position.

An optional third seat is available if desired, but can be mounted only in the third seat position.

If desired, all rear compartment seats may be quickly and easily removed to provide additional cargo space.

- To remove seat, loosen the wing nuts attaching the seat to the floor and slip the bolt heads out of the

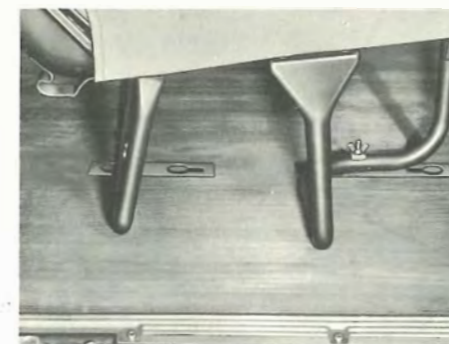

retaining slots.

- To install seat, place the seat in the desired position (fold the rear leg if second seat is being installed in third seat position), slide the four bolt heads into the slots and tighten the wing nuts.

GAS CAP

The gas cap is located below the rear of the driver's door.

CLEANING HINTS

EXTERIOR APPEARANCE

Your Corvair is finished with General Motors "Magic-Mirror" acrylic lacquer. This is a finish of maximum beauty which, in depth of color, gloss retention and durability is superior to conventional lacquer finishes.

Washing Your Corvair

The best way to preserve the finish is to keep it clean. Normally only frequent washings are required to maintain its original beauty. Wash the car in either warm or cold (never hot) water, not in the direct rays of the sun, and not while the sheet metal surfaces are hot. Never wipe dirt from dry painted surfaces because this may scratch the finish. The use of strong soaps and chemical detergents should be avoided and in any event cleaning agents should be promptly flushed from the surface and not allowed to dry or they may streak the finish.

Polishing and Waxing Your Corvair

Even though the acrylic paint on your car is more durable than conventional finishes, under certain conditions you may wish to wax or polish your car to provide maximum protection. Calcium chloride and other salts, road oil and tar, tree sap, chemicals from factory chimneys and other foreign matter may damage any known automobile finish if allowed to remain in contact with the

paint film. Prompt washing may not thoroughly remove these deposits and, particularly in geographical areas where these exposure conditions are severe, properly applied polishes and waxes of known quality will provide the best protection. Chevrolet Dealers offer G. M. Acry-Mel Hand Applied Cleaner and Polish and G. M. Triple Action Cleaner and Polish; both are excellent for use on acrylic finishes. Road oil and tar removers must be warranted safe for use on acrylic finishes. Chevrolet recommends G. M. Road Oil and Tar Remover.

Protection of Exterior Bright Metal Parts

All bright metal parts of the car should be regularly cleaned and protected against the same substances harmful to the painted surfaces. Normally, washing with water is all that is required. Never use chrome polish, steam or any caustic soap to clean ALUMINUM. Wash only with luke-warm water, and if necessary, a mild soap. Rinse well and dry thoroughly. Severe cases may be cleaned with a cleaning compound specified for acrylic finishes.

It is recommended that all bright metal parts of your Corvair, after being thoroughly cleaned, be given a coating of wax and rubbed to a high polish. This will serve to keep corrosive agents away from these surfaces, and should be repeated as often as required.

Cleaning White Sidewall Tires

Use soap, warm water or a tire cleaner and a stiff brush to remove road grime and dirt from white sidewall tires. A fine grade of steel wool will remove severe curb scrapes. Do not use gasoline, kerosene or any oil product which would discolor or deteriorate the rubber.

CAUTION: Some white sidewall cleaners will cause serious damage to aluminum trim. Use caution when cleaning tires with this type of cleaner.

CORVAIR MODELS

BRIGHT METAL TRIM—TYPE AND LOCATION	
ALUMINUM	Headlight Frames Parking Light Frames Tail Light Frames Backup Lamp Frames or Cover Plate Exhaust Grille Panel
CHROME	Body Front Panel Molding Bumpers Front Emblem Push Button Door Handles Door Key Locks Nameplates Ventipane Frame
STAINLESS STEEL	All bright metal trim not listed above may be assumed to be stainless steel.

INTERIOR APPEARANCE

Dust and Dirt

Clean the interior of your car frequently, using a broom or vacuum cleaner. A damp cloth will wipe dust from hard surfaces.

Spots and Stains

Remove upholstery stains as soon as possible or they may become "set" and difficult or impossible to remove. First determine the type and age of the stain and the kind of upholstery material. Kar Kleen Upholstery Cleaner, available from your Authorized Chevrolet Dealer, will remove most stains. Do not use alkaline cleaners for they may damage the color or finish of the materials. Other solutions such as hot or cold water, ammonia water, soap, ink eradicator, etc., will probably discolor and disturb the material.

GASOLINE AND ENGINE OIL

In the selection of gasoline and engine oil to be used, it is best to consider the reputation of the refiner or marketer. This is the best means of obtaining gasoline and oil of high quality.

Gasoline

The Corvair Turbo-Air 95 horsepower engine is designed to operate efficiently on regular grade gasolines commonly sold in the United States and Canada.

The higher horsepower performance engines are designed to operate efficiently on premium grade gasolines commonly sold in the United States and Canada. Use of regular grade gasolines in these higher performance engines may result in excessive knocking.

Since the octane quality of all regular grade or of all premium grade gasolines is not the same and factors such as altitude, terrain and air temperature affect operating efficiency, excessive knocking may result, even though you are using the grade of gasoline recommended for your engine. If excessive knocking occurs in your engine, it may be necessary to use the next higher grade of gasoline, and if knocking continues, consult your Authorized Chevrolet Dealer.

If you plan to operate your Corvair outside the continental limits of the United States or Canada, there is a possibility that the best fuels available are so low

in octane quality that excessive knocking and serious engine trouble may result from their use. To minimize this possibility, write to Chevrolet Motor Division, General Motors Corporation, Service Operations Department, Detroit, Michigan 48202 giving: Your engine serial number (see page 44), the compression ratio of your engine (see page 44) and the country or countries in which you plan to travel. You will be furnished details of adjustments or modifications which should be made to your engine by your Chevrolet dealer prior to your departure. After arriving in a foreign country, contact the nearest authorized General Motors dealer for brand names of the best fuels available and advice as to where they may be purchased.

In all cases excessive knocking should be avoided as much as possible in order to prevent possible engine damage. Operation of your car under conditions of continuous or excessive knocking constitutes misuse of the engine for which the Chevrolet Division is not responsible under the terms of the manufacturer's New Vehicle Warranty.

ENGINE LUBRICATION

The use of a high quality oil of the correct viscosity is your best assurance of continued reliability and performance from your engine. It is recommended that

you use an oil which, according to the label on the can is (1) intended for service MS and (2) passes car makers' tests or meets General Motors Standard GM 4745-M. Oils conforming to these types contain detergent additives. Your serviceman will be pleased to assist you in selecting the proper oil for your car.

Check the oil level (with the engine hot) on the dipstick frequently. Keep oil level between the FULL and ADD marks, by adding oil when level is at or below ADD mark. Do not overfill. Poor performance and possible engine damage may result if the crankcase is overfilled. Drain and refill the crankcase very 60 days or 6000 miles, whichever occurs first.

For vehicles in heavy duty operation involving continuous stop-start or prolonged idling, engine oil should be changed after 2500-3000 miles of operation.

NOTE: When checking or adding oil, be careful to avoid spilling or dropping oil onto the engine shrouding.

LOWEST ANTICIPATED TEMP.	RECOMMENDED SAE VISCOSITY OIL	
	SINGLE VISCOSITY	MULTI-VISCOSITY
32° F.	SAE-30	SAE-10W-30
10° F.	SAE-10W	SAE-10W-30
Below -10° F.	SAE-5W	SAE-5W-20

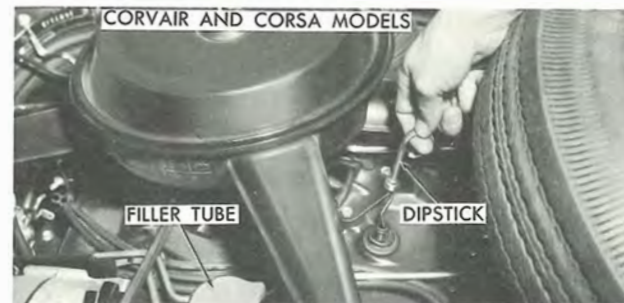

COOLING SYSTEM CARE

The engine fan belt should be checked for tightness at regular intervals. When a new belt is needed use only the approved premium belt available from your Chevrolet dealer. If any other belt is installed, replace with recommended belt when possible.

Watch the TEMP-PRESS and GEN-FAN indicators on the instrument panel for signs of overheating.

Air inlet louvers, located in the panel below the rear window on Corvair models, or in the Corvair Greenbrier upper rear quarter panels, supply air for engine combustion and cooling and for the Direct Air Heater. Make sure the louvers are never sealed or blocked.

BATTERY CARE

Check fluid level frequently. Keep filled with distilled water to level of split ring in vent tube.

TIRE CARE

Keep your tires inflated to the recommended pressures. Over-inflation can adversely affect riding comfort, quietness and tire life while under-inflation affects vehicle handling and tire life.

RECOMMENDED TIRE INFLATION PRESSURES (Based on Original Equipment Tires)

CORVAIR (6.50-13 4 PR Tires)	Cold*		Hot**	
	Front	Rear	Front	Rear
Average Owner Service up to 5-passenger load (normal inflation)				
Air conditioned models and convertibles	15	28	18	33
All other models	15	26	18	31
Continuous Service with up to full load capacity or high speeds (maximum inflation)	19	30	22	35

NOTE: As shown in the above table, Corvaire rear tire pressures should be maintained at least 11 psi higher than front tire pressures.

CORVAIR 95					
7.00 x 14-4 ply S.P.		24	30	28	35
7.00 x 14-6 ply S.P.		24	34	28	39
7.00 x 14-6 ply	Light Truck	24	45	28	50
7.00 x 14-8 ply	Type	24	60	28	65

Spare Tire—Inflate to proper Rear (Cold) pressure. Deflate to correct pressure when using as front tire.

*After car has been parked for 3 hours or more or driven less than one mile.

**Pressures can rise as much as 7 pounds above cold figures depending on loads carried, length of driving, and car speed prior to check.

Front tire loads increase appreciably with cargo loading; therefore the above is recommended for best steering characteristics.

Full load capacity of the vehicle is 1000 lbs. total. Consisting of 3 passengers in front seat, 3 passengers in rear seat and 100 lbs. luggage.

Manufacturer's original equipment 4-ply rating tires are designed and thoroughly tested to meet all normal requirements of your vehicle as outlined above.

For continuous full load service or heavy duty operation, eight ply rated tire options are recommended at the above recommended tire pressures.

Switching Tires

When rear tires are replaced, put new tires on front and used on rear and reset to recommended tire pressures.

FOR MAXIMUM TIRE LIFE

- Keep tires properly inflated.
- Check regularly for cuts, bruises and puncturing objects. Nails etc. will often be carried in the tire with no noticeable loss of air. Do not remove a puncturing object until prepared to change or repair the tire.
- Avoid unnecessary sudden starts and stops; take curves and corners slowly.
- Avoid driving over curves, sharp objects or chuckholes.
- Have wheel alignment checked periodically, especially when tires show unusual wear.

Inspection and Repair

Inspect frequently for puncturing objects in the tires. If any are found, do not attempt removal until you are in a position to change the tire or have it repaired. Also, check regularly that the wheel rim has sustained no damage which could affect the air seal.

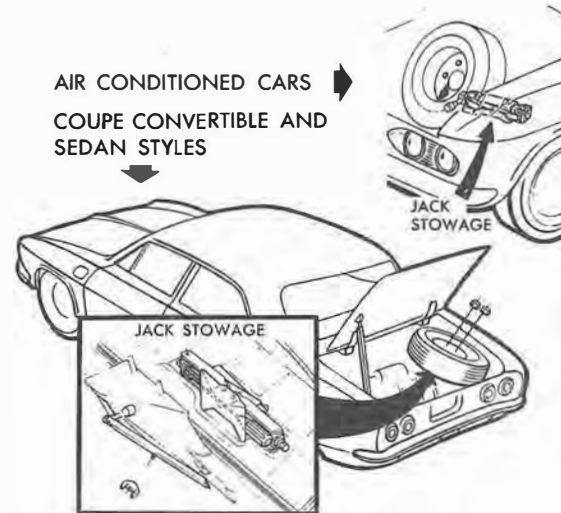

SPARE TIRE AND JACK STOWAGE

Spare tire and jack stowage for the different styles are illustrated below. On models with the spare tire located in the engine compartment, mount the wheel on the locating studs with the valve opening downward and toward the center of the car.

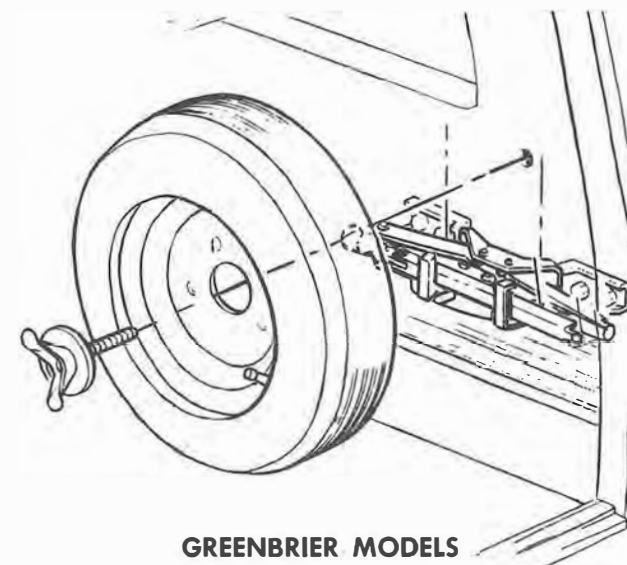

Jacking the Car

The scissors type jack and its wrench are stowed in the different models as illustrated. The opposite end of the wrench is shaped into a "finger" designed for use in removing the hub caps.

CAUTION: Never attempt to raise the Corvaire by placing any kind of jack under the bumper.

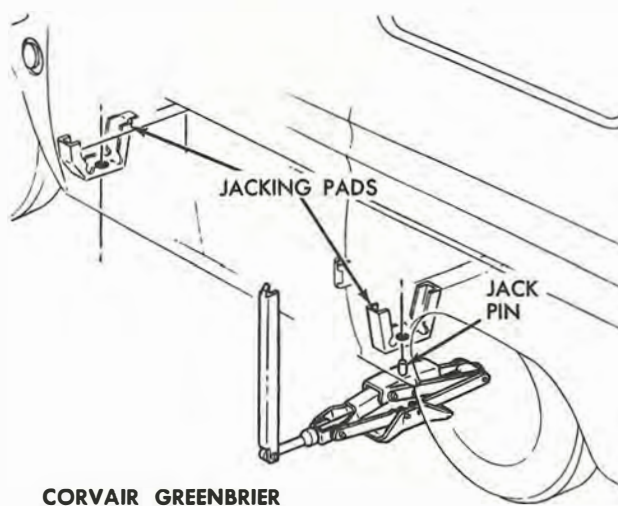
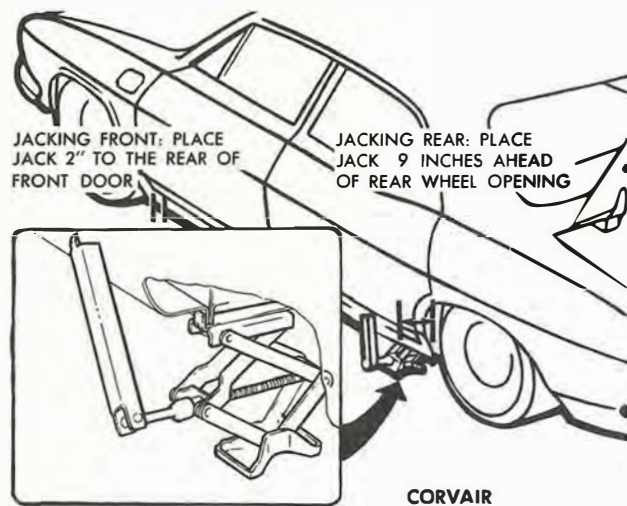

When jacking the car, set the hand brake, block diagonal wheel, and, if changing wheels, remove the hub cap and loosen wheel nuts. Place the jack under the side of the car located as shown.

PERIODIC MAINTENANCE AND LUBRICATION

The time or mileage intervals on the following pages are intended as a general guide for establishing regular maintenance and lubrication periods for your Corvaire. Sustained heavy duty or high speed operations or operation under adverse conditions may necessitate more frequent servicing. For specific recommendations for conditions under which you use your vehicle, consult your authorized Chevrolet Dealer.



ENGINE OIL CHANGE*

See "Engine Lubrication" in previous pages.

OIL FILTER*

Change the filter element every 6000 miles or every six months, whichever occurs first.

CRANKCASE VENTILATION*

Valve Type (Air Conditioned Models)—Test at every oil change, replace as required.

Fixed Orifice Type—Check at every oil change, clean every 12,000 miles.

STEERING GEAR

Every 36,000 miles—Remove filler plug and check lubricant level. If necessary add water resistant EP lubricant to bring to level of filler plug hole.

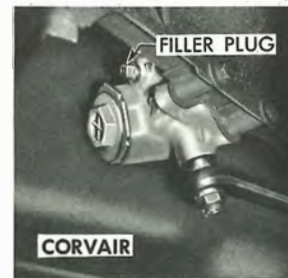

*More often under prolonged dusty driving conditions.

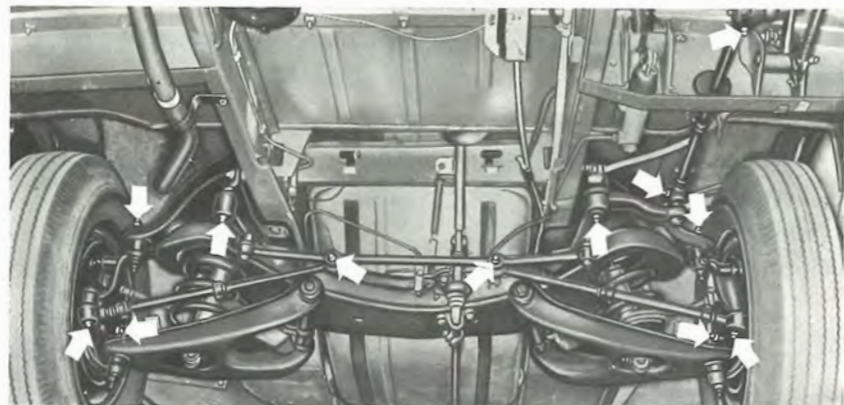

CHASSIS LUBRICANT

Every 6,000 miles or six months lubricate the chassis, at the points listed below, with a water resistant EP Chassis Lubricant.

Corvair Greenbrier

Front Suspension—4 Lubrication Fittings
Steering Linkage—8 Lubrication Fittings
Clutch Pedal Pivot—1 Lubrication Fitting
Brake Pedal Pivot—1 Lubrication Fitting

Clutch Linkage—Coat the exposed clutch linkage (located just ahead and to the right of the transmission).

Corvair

Front Suspension—4 Lubrication Fittings
Steering Linkage—4 Lubrication Fittings

Clutch Cross Shaft

At 36,000 miles (or sooner if necessary)—Remove plug and install lubrication fitting. Lubricate with a water resistant EP Chassis Lubricant. Lubricate every 36,000 miles thereafter.

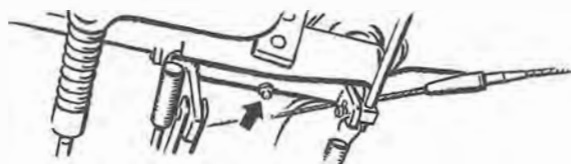

FAN BELT

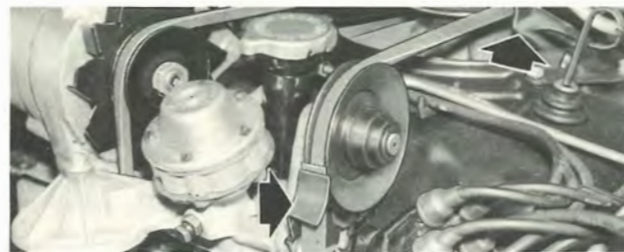

Every 6000 miles—check condition of belt. On vehicles equipped with belt guides, check belt guide to belt clearance. Belt guide clearance should be approximately 1/16" after belt is tensioned. (See page 50.)

DISTRIBUTOR CAM LUBRICATOR

Every 12,000 miles—
Rotate cam lubricator 180 degrees.

Replace lubricator at 24,000 mile intervals.

The cam lubricator should not be oiled, damage to ignition points may result if proper lubricant is not used on cam.

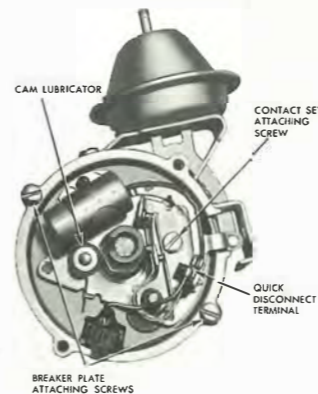

AIR CLEANER

PAPER ELEMENT TYPE (Oil-Wetted)

Every 6000 miles — Inspect or test air cleaner paper element. If inspection reveals that element is satisfactory it may be reused; however, element should be inspected or tested every 6000 miles until it is replaced. Element must not be oiled, washed, tapped or cleaned with an air hose.

Under severe dust conditions it may be necessary to inspect or test the element more often.

AIR CONDITIONING

After the first 6000 miles—have your Chevrolet Dealer check the tightness of all hose clamp connections.

Every 6000 miles—Check sight glass, located under the hood, after the system has been in operation for several minutes. Sight glass should be clear. Bubbles or dirt indicate a leak which should be corrected immediately by your Chevrolet Dealer.

BRAKE LININGS

Have the brake linings inspected periodically. Frequency of inspection will depend on traffic, terrain and the driving habits of the driver.

BRAKE MAIN CYLINDER

Every 6,000 miles—Check fluid level and maintain $\frac{1}{4}$ " below opening with G. M. Hydraulic Brake Fluid Supreme No. 11.

PARKING BRAKE AND CLUTCH PULLEYS AND CABLES—CORVAIR

Every 12,000 miles—Lubricate pulleys under dash. Remove the tunnel cover under vehicle and lubricate pulleys and cable bearing points with a water resistant EP Chassis Lubricant. Lubricate gearshift lever ball and socket (see page 41) at the same time.

FRONT WHEEL BEARINGS

Clean, repack with high melting point wheel bearing lubricant, and adjust whenever brake drums are removed. Replace grease seals at the same time.

ENGINE OIL COOLER

Every 12,000 miles (more often under prolonged dusty driving conditions)—Remove cover and brush or blow out accumulated dirt.

NOTE: Material usually found in the oil cooler consists primarily of twigs, straw, chaff, and leaves.

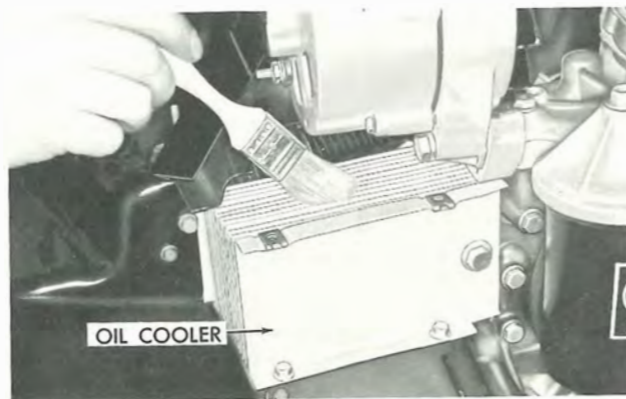

TRANSMISSION—POWERGLIDE

Every 6000 miles—Check fluid level on dipstick with engine idling, selector lever in NEUTRAL position, parking brake set and transmission at operating temperature. If fluid level is below full mark on dipstick, add small amount of Automatic Transmission Fluid Type "A" bearing the mark AQ-ATF followed by a number and the suffix letter "A". Recheck fluid level on dipstick and again add a small amount of fluid if needed to bring level to full mark. DO NOT OVERFILL.

NOTE: From the "Add Oil" mark to the "Full" mark on the dipstick indicates a difference of only 1 pint of fluid.

Every 12,000 miles (more frequently, depending on severity of service, if vehicle is used to pull trailer, carry full loads during high ambient temperatures,



operate in mountainous terrain or operate under other severe conditions)—Remove fluid from the transmission sump and add two (2) quarts of fresh fluid. Operate transmission through all ranges and check fluid level as described above.

If vehicle is so equipped, clean dust and dirt from transmission oil cooler every 12,000 miles.

TRANSMISSION—3 AND 4-SPEED

Follow recommendations given under "Rear Axle" on page 42.

TRANSMISSION CONTROL LINKAGE—3 AND 4-SPEED

Corvaire

Every 12,000 miles—Lubricate connector (indicated in the illustration below) with a water resistant EP Chassis Lubricant.

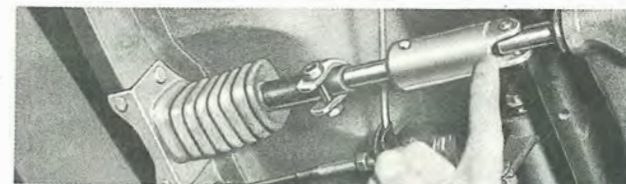

Every 12,000 miles—Remove tunnel cover under vehicle and lubricate gearshift lever ball and socket with Lubriplate.

REAR AXLE

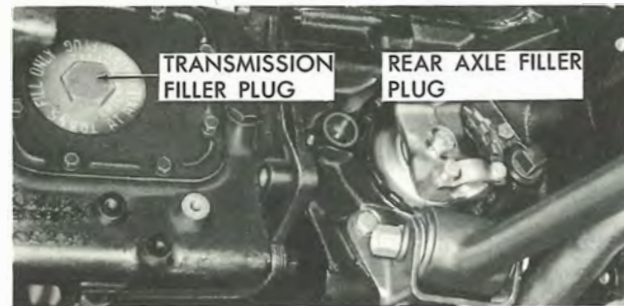

Check lubricant level, with axle at operating temperature, at the dipstick whenever engine oil is checked. The dipstick is used to check lubricant level only; do not attempt to fill axle at the dipstick tube.

If lubricant level is at or below ADD mark on dipstick, fill to level of the filler plug hole with SAE 80 Multi-purpose Gear Lubricant meeting the requirements of U.S. Ordnance Spec. MIL-L-2105B.

Check 3- or 4-speed lubricant level, if the rear axle lubricant level is low.

BATTERY

Every 6000 miles—Clean and oil battery terminals and oil felt washer. Clean top of battery with diluted ammonia or soda solution and flush with clean water. Check state of charge especially in freezing weather. An undercharged battery may freeze and break.



Greenbrier Battery and Transmission Oil Cooler Access Door

FUEL FILTER

Corvair, Corsa and Greenbrier

Replace filters, located in each carburetor inlet, only if flooding occurs.



Corsa Turbocharged

The fuel filter is a separate unit mounted on the air cleaner support bracket at the left of the air cleaner. It should be replaced at 12,000 mile intervals. At the same interval, also clean the screen located in the carburetor inlet.

BODY LUBRICATION POINTS

Most body lube points do not need frequent, heavy lubrication. However, periodic checks of certain points on the Corvair body, and lubrication when needed will eliminate annoying squeaks and noises. Be careful not to over-lubricate. Wipe off all surplus lubricant.

The following items should be lubricated periodically:

1. Door Hinges—Wipe off dirt and apply Lubriplate.
2. Door Lock Striker—Wipe off dirt and apply stick type lubricant.
3. Top Lift Cylinder Rods—Clean and lubricate with G.M. Hydraulic Brake Fluid.
4. Door Jamb Switch—Apply Lubriplate.
5. Front and Rear Compartment Lid Lock—Apply Lubriplate.
6. Front Compartment Lid Torque Rods—Apply G.M. Lubriplate to bearing points.

7. Gas Tank Filler Door Hinge—Apply driplless oil.

8. Glove Box Door Hinge—Apply driplless oil.

9. Rear Folding Seat Back Support Link Assembly and Filler Panel Hinge—Apply driplless oil to bearing points.

The following should be lubricated whenever accessible.

10. Door Outside Handle Lock Cylinder Shaft—Apply Lubriplate.

11. Door Window Regulator and Cams—Apply Lubriplate.

12. Door Lock Parts—Apply Lubriplate.

13. Door Locking Mechanism—Apply Lubriplate.

14. Front and Rear Compartment Hinges—Apply G.M. Lubriplate.

SPECIFICATIONS

SERIAL AND UNIT NUMBERS

Engine Number Stamped on the engine block behind and to left of the fuel pump.

Body Number Corvair—Stamped on a plate attached to top of rear rail to left of engine mount, within the engine compartment.
Corvair Greenbrier—Stamped on a plate attached to the front inner body panel, within the drive compartment.

Serial Number Corvair—Stamped on vehicle identification plate attached to left rear side rail, within the engine compartment.
Corvair Greenbrier—Stamped on vehicle identification plate attached to the left front door lock pillar.

DIMENSIONS

Length:
Corvair Greenbrier 179.7 in.
Corvair 183.3 in.

Width:
Corvair Greenbrier 70.0 in.
Corvair 69.7 in.

Height:
Corvair Greenbrier 68.5 in.
Corvair Sport Sedan 51.2 in.
Corvair Sport Coupe 51.3 in.
Corvair Convertible 51.5 in.

Wheel Base:
Corvair Greenbrier 95.0 in.
Corvair 108.0 in.

Turning Diameter:
Corvair Greenbrier 42.6 ft.
Corvair 36.0 ft.

Greenbrier—Load Length 106.2 in.
Greenbrier—Load Width 59.4 in.
Greenbrier—Load Compartment Height 54.0 in.

Side Loading Doors—Width 4.90 x 53.5 in.
Rear Loading Doors 36.0 x 44.6 in.

CAPACITIES

Gasoline Tank:
Corvair Greenbrier 18.5 gal.
Corvair 14.0 gal.
Crankcase Refill 4 qt.
Add for filter 1 pt.

Transmission:
3-Speed 2 pt.
4-Speed 3 pt.
Differential 4½ pt.
Cooling System Air Cooled Engine

ENGINE SPECIFICATIONS

Horsepower:
95 hp Turbo-Air 164 95 @ 3600 rpm
110 hp Turbo-Air 164 110 @ 4400 rpm
140 hp Turbo-Air 164 140 @ 5200 rpm
180 hp Turbocharged 164 180 @ 4000 rpm

Compression Ratio:
95 hp Turbo-Air 164 8.25:1
110 and 140 hp Turbo-Air 164 9.25:1
180 hp Turbocharged 164 8.25:1

Displacement 164 cu. in.
Bore and Stroke (all engines) 3⁷/₁₆" x 2.94"
Firing Order 1-4-5-2-3-6

Spark Plugs:
95 hp Turbo-Air 164 (Gap .035) AC-46-FF
110 and 140 hp Turbo-Air 164 and 180 hp Turbocharged 164 (Gap .030) AC-44-FF

Idle Speed:

95 hp Turbo-Air 164 w/manual trans. (In Neutral) 450-500 rpm
110 hp Turbo-Air 164 w/manual trans. (In Neutral) 600-650 rpm
140 hp Turbo-Air 164 w/manual trans. (In Neutral) 600-650 rpm
180 hp Turbocharged 164 (In Neutral) 850 rpm
All Powerglide (In Drive) 450-500 rpm

Ignition Timing:

95 hp Turbo-Air 164 (manual transmission) 6° BTDC
110 hp Turbo-Air 164 (manual transmission) 14° BTDC
140 hp Turgo-Air 164 18° BTDC
180 hp Turbocharged 164 24° BTDC
All Powerglide 14° BTDC

Axle Ratios:

Engine	Transmission	Standard Ratio*
95 hp Turbo-Air 164	All	3.27:1
110 hp Turbo-Air 164	3- and 4-Speed	3.27:1
	Powerglide	3.55:1
140 hp Turbo-Air 164	3- and 4-Speed	3.55:1
180 hp Turbocharged 164	All	3.55:1

*Standard Ratio For Corvair Greenbrier and Air Conditioning Equipped Vehicles 3.55:1.

BULB SPECIFICATIONS

Headlamp Unit (Sealed Beam)	Candle Power	Number
Outer—High Beam	37½W	4002
Low Beam	55W	
Inner—High Beam Only	37½W	4001
Parking Lamp-Directional Signal and Tail-Stop-Directional Signal Lamps	4-32	1157
Back-Up Lamps	32	1156
Instrument Lamps	3	GE 1816
Temp. Press., Gen. Fan., and Glove Compartment Lamps	2	1895
Headlamp High Beam Indicator, Directional Signal Indicator, and Heater Control Panel Lamps	1	1445

Dome Lamp	12	211
Courtesy Lamp	6	631
License Plate Lamp	4	67
Radio Dial Lamp	2	1893

BATTERY RATINGS

Corvair—12 volt; 54 plate; 44 amp/hr.
Corvair 95 and Greenbrier—12 volt; 54 plate; 42 amp/hr.

FUSES AND CIRCUIT BREAKER

A circuit breaker in the light control switch protects the headlamp circuit, thus eliminating one fuse. Where current load is too heavy, the circuit breaker intermittently opens and closes, protecting the circuit until the cause is found and eliminated.

Fuses, located in the junction block beneath the dash are:

- Heater Blower
Glove Compartment Lamp 3AG/AGC-10 amp
- Tail and Stop Lamps,
Dome Lamp 3AG/AGC-10 amp.
- Heater (Total System)
Back-up Lamp 3AG/AGC-20 amp.
- Radio (AM or AM-FM) 3AG/AGC-2½ amp.
(AM-FM Stereo) 3AG/AGC-7½ amp.
- Instrument Panel Lamps
Radio Panel Lamp
Heater Control Panel Lamp 3AG/AGC-3 amp.
- Windshield Wiper Motor 3AG/AGC-20 amp.
Air Conditioner Fuses 3AG/AGC-15 amp.
(Located in 14GA red and 12GA gray wires in area of ignition switch.)

TRAILERS AND THEIR EFFECT ON CAR OPERATION

Corvair passenger cars are designed primarily for passenger conveyance. However, it is well known that many owners do use the Corvair to pull trailers, and when available trailer hauling options have been used, the owners have experienced very satisfactory service.

When a trailer is attached to a car, the car becomes not only a load-carrying vehicle, but a load-pulling vehicle. The demands of this type of operation are very different from those for which the automobile is primarily designed and may present problems, such as spring and tire loading, braking, cooling, lighting, and steering. However, careful driving practices and the use of factory-recommended options will better satisfy the requirements of trailer hauling.

If in the opinion of the manufacturer a part or component of a motor vehicle has been adversely affected

by misuse of the vehicle with trailer loads, such part or component will not be covered by the manufacturer's warranty.

The size of and equipment for trailers, including such items as hitches and safety chains, brakes, lights, power-weight ratios and over-all length, are generally subject to safety regulations in all states, and it is the responsibility of the user to make certain that he is in full compliance with the regulations of the states in which he plans to operate with a trailer of the Interstate Commerce Commission, if applicable, before doing so. Further, when operating a car with a trailer attached, the driver must realize that the performance, steering characteristics, and braking distance of his car have been altered, and that he must exercise greater caution to safely handle his car and trailer.

MINOR TROUBLE SHOOTING GUIDE

	FUEL SYSTEM AND ENGINE								ELECTRICAL SYSTEM								COOLING SYSTEM				
	Check Fuel Gauge	Flooded Carburetor	Empty Carburetor Bowl	Poor Fuel Supply to Carburetor	Idle Adjustment*	Stuck Choke Valve*	Oil Level and Pressure	Condition of Air Cleaners	Malfunctioning Ignition Switch	Automatic Transmission Selector Lever	Check Spark	Battery and Connections	Generator and Voltage Regulator Connections	Coil and Distributor Leads	Starter Connections and Solenoid	Damp Electrical Connections	Generator Condition*	Air Flow Through Engine Restricted	Fan Belt Condition and Tension Adjustment	Cooling System*	Thorough Check and Tune-up Suggested*
If your car acts in the following manner:																					
Check here in sequence shown for possible causes.																					
On the following pages, see paragraph:	A	B	D	B-C-D	E	D	L	E	F	F	K	G	G	J	H	I	G	M	N	O	
See information on page number:	8						9-32	39		3-6		42					9				
CAR WILL NOT START:																					
Engine Will Turn Over	1	4		3							6			2		5					7
Engine Will Not Turn Over									2	1		3		4							
CAR WILL START—BUT:																					
Only After Repeated Tries										1											
Stalls in a Few Seconds			2	1	3																
Stalls When Hot					1	2		3													4
Idles Rough					1			2													3
Engine Overheats																		1	2	3	
"Oil" Indicator Comes On							1														
"Gen" Indicator Comes On											3	2					4		1		

*See Your Authorized Chevrolet Dealer

MINOR TROUBLE SHOOTING PROCEDURES

The chart on the previous page, and the information on the pages which follow, contains information designed to aid the average driver to discover, and possibly correct, conditions resulting in minor mechanical difficulties in his car. The chart, designed to point out possible solutions to several of the most common automotive malfunctions and point out a logical checking sequence, will lead step by step to the most likely causes and corrective procedures. If, after making the checks and adjustments suggested, the source of the trouble has not been found and corrected, it is strongly recommended that an Authorized Chevrolet Dealer inspect the vehicle and make whatever repairs or adjustments are necessary.

FUEL SYSTEM AND ENGINE

If the ignition switch will cause the engine to "turn over" or "crank" but the car will not start, check Steps A through D below.

NOTE: If continual "flooding" of the carburetor is evidenced by a carburetor wet with fuel or black exhaust smoke, perform the operation suggested in paragraph D only.

(A) The first and most obvious, and one of the most frequently overlooked, items to check when you have difficulty in starting your car is the amount of fuel in the tank. Make it a habit to check the FUEL GAUGE regularly and most especially at a time when the engine will "turn over" but will not start.

(B) If the fuel tank is not empty,



Checking Fuel Flow

you may check further to see whether the fuel is reaching the engine. Disconnect the fuel lines at the carburetor. Place a jar or cup under open line and briefly "crank" the engine by means of the starter. If fuel spurts from the line, you may assume that the FUEL LINES are clear and the FUEL PUMP is operating properly. If no fuel leaves the line, either the fuel lines or fuel pump are at fault. See your Authorized Chevrolet Dealer.

(C) Before reconnecting the fuel lines to the carburetor, remove the FUEL FILTER from carburetor inlet and check its condition. If it appears to be clean, replace it and reconnect the fuel lines. If the filter appears to be plugged, clean it as well as possible by scraping out the foreign material and cleaning in a solvent. Then reinstall the filter and repeat the procedure with the second carburetor. Replace the filters with new ones as soon as possible.

(D) If the fuel seems to be reaching the carburetors properly, the problem may be: an EMPTY CARBURETOR BOWL caused by a "stuck shut" float valve or a FLOODED CARBURETOR caused by a "stuck open" condition and evidenced by gasoline flowing down the outside of the carburetor; or a stuck CHOKE valve. Remove the air cleaners from the carburetors. Check that the choke valves move freely and are not stuck. Tap the side of the carburetors sharply several times with a light tool such as a screwdriver handle or pliers. Replace the air cleaners and attempt to start the engine in the normal manner.

(E) If the car will start but stalls when hot or has a rough idle, you can suspect a faulty IDLE ADJUSTMENT, or extremely dirty

and blocked AIR CLEANER ELEMENTS. Clean and reoil the air cleaner elements if necessary. Idle adjustment should be performed by your Chevrolet Dealer.

If the above Fuel System checks and the checks suggested under the Electrical System following do not correct the malfunction, it is recommended that you turn to your Authorized Chevrolet Dealer for further checks, adjustments or repairs.

ELECTRICAL SYSTEM

If, when the ignition key is turned to START, the engine will not turn over, you have good reason to suspect electrical trouble.

(F) When there is no response at all to attempts to start the car, check the obvious—your AUTOMATIC TRANSMISSION SELECTOR LEVER must be in neutral position before the engine can be started. Turning the IGNITION SWITCH rapidly back and forth several times will sometimes correct a poor internal switch contact.

(G) The BATTERY may be discharged. If so, lights will be dim and the horn will have a poor tone if it will blow at all.

Usually a garage recharge will be necessary to return the battery to operation. Occasionally, however, a push start and a long drive will recharge the battery.

NOTE: If the battery is determined to be dead, and for no apparent reason, have your Authorized Chevrolet Dealer check the battery, the GENERATOR and the VOLTAGE REGULATOR. GENERATOR trouble should already have been indicated by the indicator on the instrument panel. Never remove generator "BAT" lead without first disconnecting battery ground cable.

POOR BATTERY CONNECTIONS may be suspected if the car has operated properly a short time before and now not even the horn will operate. Check both ends of both battery cables. If the connections are corroded, a car may sometimes be restored to operation by removing all cable ends, scraping all contacting surfaces clean with a pen knife, and reassembling. If the cables are broken, they must be replaced. The power supply should now be restored unless the battery is dead.

(H) If, however, the lights and horn work properly but the starter will still not turn over, check the STARTER connections. A "click" from the starter solenoid indicates that the wiring to the starter is properly installed. If the wiring seems to be clean and tightly installed, the trouble is probably in the starter itself and should be referred to your Authorized Chevrolet Dealer.

When the engine will "turn over" but will not start, the following items may be checked along with Fuel System Checks listed previously.

(I) With a clean dry cloth wipe the ceramic portions of the spark plugs dry. In particularly damp or rainy weather dampness may be the cause of not starting, especially when the engine is cold.

(J) Check the cables at the top of the distributor and coil as well as each spark plug cable for tightness.

(K) If the car will still not start, check for spark at the spark plugs in the following manner:

Pull one of the spark plug wires off its spark plug. Insert a short piece of bare wire (such as a bobby pin) between the rubber



Distributor and Coil Leads

cup at the end of the spark plug wire and the tubular metal connector inside of it. If the spark plug wire is wet or oily, wipe it dry. Wrap a dry handkerchief or facial tissue, folded several thicknesses, around the wire at least three inches back from the end and grasp wire at this point. Hold the bare wire about 1/4 inch from the bare tip of the spark plug from which you removed the wire. When the engine is "turned

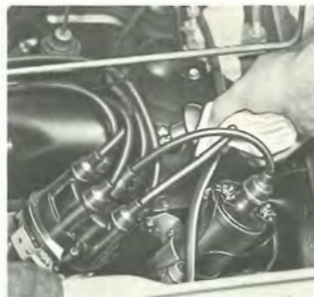

Checking for Spark

over" a spark should jump across the 1/4 inch space, indicating ample current supply. If no spark jumps, the difficulty is probably caused by a defective ignition part and should be corrected by your Authorized Chevrolet Dealer.

COOLING SYSTEM

When the car will run but evidences serious overheating on the temperature gauge in the instrument panel, there are several items which may be checked.

(L) Engine overheating will occur when the OIL LEVEL falls dangerously low. Check the oil level as a matter of course.

CAUTION: Never drive the car when the TEMP-PRESS indicator in the instrument panel is lighted. (See Page 9.)

(M) Check the air intake louvers. Clean them if they are plugged with leaves or other foreign material.

(N) Condition of the FAN BELT is very important, not only for engine cooling but also for proper generator operation. Check the condition of the belt. Replace it if it is worn or frayed. Loosen the idler bracket bolts and move the bracket toward the engine to remove and replace the belt. Tighten the belt, whether new or old, by loosening the idler bracket nuts, prying with a bar on the bracket until the belt is tensioned properly, then retighten the bracket bolts. Proper belt tension is such that, when belt is deflected downward with moderate thumb pressure at a point midway between the generator and fan pulleys, the belt will deflect about 3/8" to 1/2". Do not overtighten the belt.

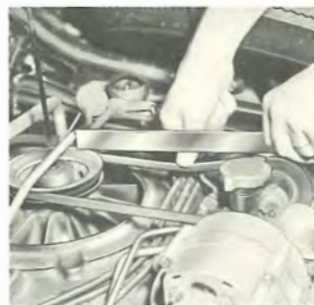

Checking Fan Belt Tension

(O) Another cause of engine overheating may be an inoperative COOLING SYSTEM THERMOSTAT. If the thermostat should fail in the closed position, it will not permit air to circulate through the engine. See your Authorized Chevrolet Dealer.

INDEX

	Page		Page
Air Cleaner	39	Cylinder Head Temperature Gauge	23
Air Conditioning	15 & 40	Dimmer Switch	11
Air Recirculating Cover Plate	15	Distributor	39
Air Vents	17	Doors and Locks	18 & 26
Ash Tray	17 & 26	Rear	19 & 27
Battery	33 & 42	Side	27
Body Lubrication	43	Driving for Economy	2
Brake Main Cylinder	40	Engine Oil Cooler	40
Brake—Parking	12	Engine Compartment	21 & 26
Brakes	12	Engine Lubrication	32
Bright Metal Parts		Front Suspension	38
Protection	30	Front Wheel Bearings	40
Type and Location	31	Fuel Filter	42
Chassis Lubrication	38	Fuel Gauge	8
Cigarette Lighter	17	Fuses	45
Circuit Breaker	45	Gas Cap	21 & 29
Cleaning Hints		Generator	39
Exterior Appearance	30	Gen-Fan Indicator	9 & 23
Interior Appearance	31	Heater	
Clutch Adjustment	12	Direct Air	14
Clutch Cross Shaft	38	Gasoline	24
Clutch Pedal	12	Ignition Switch	3
Clutch Pulleys & Cables	40	Jacking the Car	36
Cooling System	33	Keys	18
Crankcase Ventilation	37	Light Control Knob	10
		Lighting System Trouble Checks	11

TRUCK SHOP MANUAL

FORM NO.	YEAR	PRICE EA.
RS-56	(1954)	\$3.75
RS-54	(1955)	3.25
S & M-56	(1956*)	3.00
RS-61	(1957)	3.25
RS-63	(1958)	3.50
S & M-16	(1959*)	1.50
S & M-22	(1960)	3.75
ST-9	(1960-62*)	4.00
ST-22	(1963)	4.75
ST-35	(1964 supplement)	2.75
H-15	(1964 w/'63 for complete cover.)	5.50
ST-61	(1965 supplement)	2.75
H-20	(1965 w/'63 for complete cover.)	5.50

CHEVY VAN SHOP MANUAL

OWNER GUIDES

Chevrolet, Chevy II, Corvair, Corvair 95 and Chevelle	.30 each
Truck and Chevy Van	.40 each
Corvette	.60 each
Convertible Top booklets	.25 each

Please specify model year and vehicle when ordering.

*Previous year model manual must be ordered with this supplement to obtain complete coverage.

AVAILABLE CHEVROLET SHOP MANUALS PRIOR TO 1949

The shop manuals listed below are out of print. The information contained in these shop manuals has been prepared on microfilm. We are able to produce a 35 mm positive film strip from this microfilm. The film can be viewed through any type of film viewer adaptable to 35 mm.

AVAILABLE FILMS

- 1919 Chevrolet Car Shop Manual
 - 1923 through 1948 Chevrolet Shop Manuals
 - 1934 through 1952 Truck Shop Manuals
- Price **\$5.00 Each**

(For 1953 Truck Shop Manual, Order 1952.)

Please allow 30 days for order to be filled.

NOTE: PLEASE FILL ORDER FORM IN COMPLETELY, CUT HERE AND MAIL TO:

HELM Incorporated

Post Office Box 7706
Detroit, Michigan 48207

Please mail Check or Money Order (NO STAMPS) for the publications you have ordered on form.

NOTE: Purchasers outside Domestic U.S.A. must add 30c to each publication for mailing expense. Funds MUST be payable in U. S. Currency. All orders will be mailed within 10 days of receipt of order. Please allow approximately 30 days for postal service.

QUANTITY	FORM NO.	YEAR	PRICE EA.	TOTAL

Remarks

Michigan Purchasers —
add
4% Sales Tax

Total Order
(of both columns)
Michigan Sales Tax

Grand Total

Prices subject to change after July 1, 1965

PLEASE COMPLETE SHIPPING LABEL BELOW

SIGNATURE OF PURCHASER

STREET ADDRESS

IMPORTANT: This is your shipping label — Please print clearly

CITY, POSTAL ZONE, STATE

From...

HELM Inc. Chevrolet Manual Distribution Department

POST OFFICE BOX 7706

• DETROIT, MICHIGAN 48207

To

(NAME)

(STREET ADDRESS)

(CITY, ZONE STATE)

RETURN REQUESTED

CHEVROLET OWNER PROTECTION PLAN

The Chevrolet Motor Division considers it a most important obligation to offer each owner a recommended maintenance service guide which will relieve him of any anxiety and insure that his vehicle is regularly inspected and maintained.

Your Chevrolet dealer has presented you with a Chevrolet Owner Protection Plan Booklet. The Recommended Maintenance and Lubrication Service items in this booklet have been worked out by Chevrolet service personnel and cover items which are the owner's responsibility to have checked, inspected, adjusted and lubricated at recommended time or mileage intervals.

If the services are carried out at the prescribed time or mileage intervals, wear and owner expense will be kept to a minimum. Additional services may become necessary as mileage accrues, however, the regular visit that you make to your Chevrolet dealer in following this Plan will point out desirable services as they become necessary.

In the event warranty repair is required on your Corvair, the Chevrolet Protect-O-Plate affixed to the back cover of your Protection Plan booklet will assist in identifying you and your Corvair to your Chevrolet dealer.



Litho in U.S.A.—Part #3859590