

Whether you have chosen the 1963 Chevrolet Corvair, the Corvair Spyder, or the equally dependable Corvair 95, you are assured of the usual high degree of Chevrolet excellence in design and manufacture.

The information and suggestions found in this owners guide can help you enjoy to the fullest, all of the advantages and features built into your Corvair.

Your Chevrolet dealer is well trained and equipped to inspect and service your Corvair and keep it ready to provide new car service and performance. Have him inspect and service your car at regular intervals.

We would also like to take this opportunity to thank you for choosing Chevrolet—and to assure you of our continuing interest in your motoring pleasure and satisfaction.

CHEVROLET MOTOR DIVISION • GENERAL MOTORS CORPORATION
DETROIT 2, MICHIGAN

TABLE OF CONTENTS

	Page
Corvair	
Operating Instructions	2
Instruments	8
Controls	10
Corvair Spyder	22
Corvair 95	24
Cleaning Hints	30
Maintenance and Lubrication	32
Specifications	44
Service Accessories	46
Minor Trouble Shooting Guide	47
Minor Trouble Shooting Procedures	48
Index	51
Owner Protection Plan	Inside Back Cover

All information contained in this booklet is based on the latest product information available at the time of printing. The right is reserved to make changes at any time without notice.

YOUR CORVAIR'S FIRST FEW HUNDRED MILES OF DRIVING

Sound design and precision manufacturing methods will permit you to operate your new Corvair in a normal manner from its very first mile without adhering to a formal "break-in" schedule. However, during the first few hundred miles of driving you can, by observing a few simple precautions, add to the future performance and economy of your car.

It is recommended that your speed during the first 500 miles be confined to a maximum of 60 MPH, but do not drive for extended periods at any one constant speed, either fast or slow. During this period, avoid full

throttle "jock-rabbit" starts and unnecessary, quick, abrupt stops.

Gentle braking during the first few hundred miles of operation will result in longer brake life and better future performance. Avoid unnecessary, hard stops especially during the first 200 miles of operation since brake misuse during this period will destroy much future brake efficiency.

Always drive at a moderate speed until the engine has completely warmed up.

DRIVING FOR ECONOMY

Praper maintenance and wise operation will combine to help you achieve maximum fuel economy with your Corvair. Your Authorized Chevrolet Dealer can properly tune and maintain your car but wise operation is your responsibility. Give the car sufficient warm-up

time, do not make "jack rabbit" starts or unnecessary skidding stops, and drive at reasonable speeds and as steady as traffic permits to gain the benefits of all the economy built into your Corvair.

CAUTION: Carbon monoxide is a poisonous gas produced by the engine of any car. It is odorless, so you cannot detect its presence. Be safe. Never start or run engine in a closed garage.

STARTING THE ENGINE

IGNITION SWITCH

LOCK OFF ON START

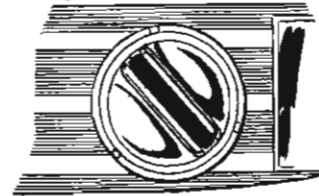

START—Used only when starting engine. When released, switch returns to ON.

ON—For normal operation after engine has been started.

OFF—Turns off engine and accessories.

LOCK—Same as OFF except that switch cannot be moved into or out of this position without ignition key. Always switch to LOCK and remove the key when leaving your car unattended.

NOTE: Key cannot be removed from switch when in OFF position, thus guarding against accidentally leaving switch OFF but not locked. The key may be removed when the switch is in ON position and the switch may then be actuated to OFF and START positions.

STARTING

1. **POWERGLIDE**—Place control lever in N position.

The engine will not start with the transmission in gear.

MANUAL TRANSMISSION—Place gearshift control lever in neutral, and depress clutch pedal to the floor.

2. Depress accelerator part way and release. In extreme cold weather (0°F. and below) or when engine is hot, accelerator pedal should be held part way down during starting.
3. Turn ignition switch to START and release as soon as engine starts.
4. "FLOODED" ENGINE—Depress accelerator to floor and hold while cranking engine. Never "pump" accelerator.

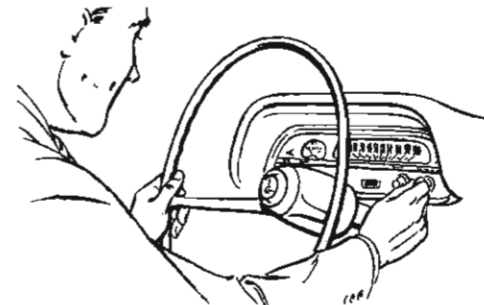

WARM-UP

Never race the engine or drive at high speeds until the engine has had a chance to warm up. Always drive at moderate speeds for several miles, especially in cold weather. Failure to allow sufficient warm-up time causes much unnecessary wear to the engine. Also, excessive speeds before axle and transmission lubricant becomes warmed up can cause harm to these parts.

DRIVING WITH THE MANUAL TRANSMISSIONS

The three-speed and optional four-speed transmissions are operated in basically the same manner. Shift patterns differ, of course, as illustrated in the two illustrations on page 5.

1st GEAR (LOW)—Depress clutch pedal, shift into 1st gear, slowly release clutch pedal while pressing on accelerator. As car gains speed, depress clutch pedal, release accelerator and move gearshift into 2nd gear.

2nd GEAR—Release clutch pedal and depress accelerator as above as car gains speed, then, in same manner

as before, move gearshift lever into 3rd gear.

3rd GEAR (HIGH)—Slowly release clutch pedal and depress accelerator pedal. This is the cruising gear for all normal driving with the 3-speed transmission. With the 4-speed transmission 3rd gear will provide more response and higher performance for driving in heavy traffic.

4th GEAR (HIGH—4-speed transmission only)
Shift into 4th gear in the same manner for normal cruising with the 4-speed transmission.

NOTE: Whenever the vehicle begins to labor in any gear, depress the clutch pedal and shift to the next lower gear.

TO STOP—Release the accelerator and depress the brake pedal. As car slows down, depress the clutch pedal and move the gearshift lever into neutral.

NEUTRAL—For use when starting or idling engine.

REVERSE—Operate as for 1st gear but always at a slow speed.

TOWING—Attaching points for lifting and towing are located in the front and rear bumper brackets.

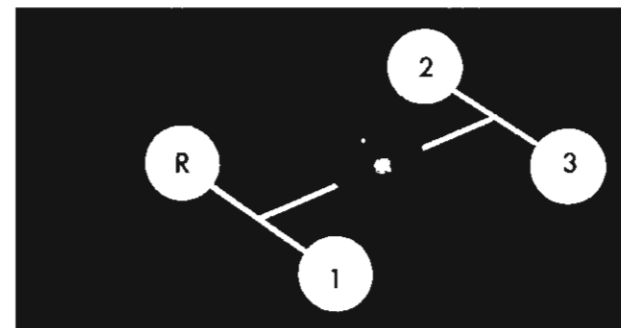

Three Speed Shift Pattern

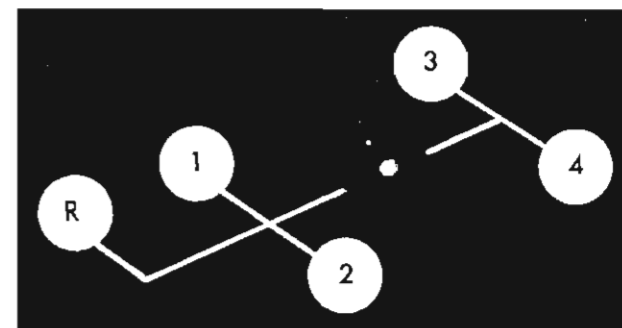

Four Speed Shift Pattern

PUSHING TO START

- Turn on key and depress clutch pedal.
- Place gearshift lever in neutral position until car speed reaches approximately 15 mph.

DRIVING WITH THE POWERGLIDE TRANSMISSION

The optional Powerglide transmission is a completely automatic transmission which replaces the standard clutch and transmission. After starting the engine with the selector lever in N (neutral) position, merely select the range desired and depress the accelerator. The Powerglide transmission will do the rest.

- Move shift lever to 3rd position and slowly release clutch pedal.
- Never attempt to start the car by towing.

more economical cruising gear in the shortest possible time. Hard acceleration for fast starts will cause the transmission to remain in low gear for a considerably longer period.

When driving at speeds below 45 mph, the transmission may be shifted back into low range for extra acceleration for passing by depressing the accelerator pedal fully. The transmission will automatically shift back into

cruising gear when the accelerator pedal is momentarily released.

PUSHING TO START

- Turn on key and move selector lever to neutral. At 20 to 25 mph move lever to L.
- When engine starts, move selector lever to D.

NOTE: Never tow to start.

OPERATING YOUR POWERGLIDE TRANSMISSION

POSITION	OPERATION	USES
R —REVERSE	For Backing Car (From Stopped Position)	NORMAL DRIVING RANGE
N —NEUTRAL	For Starting Engine (Brakes Applied)	
D —DRIVE	For all Forward Driving. Step hard on accelerator for extra acceleration below 45 mph.	
L —LOW	For Hard Pulling at Low Speeds, Climbing, or Descending Steep Grades and for additional engine braking below 40 mph.	SAND, SNOW, MUD OR ON STEEP GRADES

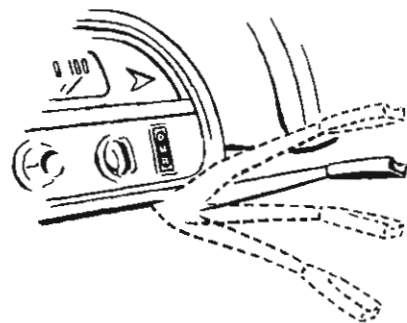

TOWING

- Place selector lever in neutral.
- If transmission or axle are malfunctioning, tow with rear wheels raised.
- When towing any vehicle on its front wheels, the steering wheel should be secured to maintain a straight forward position.
- Never tow faster than 50 mph.
- Attaching points for lifting and towing are located in the front and rear bumper brackets.

ROCKING CAR

When stuck in mud, sand or snow, you may rock the car by depressing the accelerator slightly and shifting the selector lever between R and D. Avoid excessive engine speed while performing this operation.

PARKING CAR

It is important that when your Corvair is parked the parking brake be fully engaged. Do not count on the

transmission to hold the car. Always engage the parking brake when parked.

POWERGLIDE DRIVING CAUTIONS

- Always engage parking brake when parked.
- Do not accelerate engine in L, D, or R with the brakes engaged. This can cause damage by overheating transmission.
- Do not hold car on an upgrade by accelerating engine. Use brakes.
- Use low position for hard pulls at low speed, climbing or descending steep grades and for push starting.
- Always stop car before shifting to reverse.

DRIVING WITH POSITRACTION REAR AXLE

The Positraction rear axle gives you constant driving force on both rear wheels; especially helpful in the winter and during other slippery driving conditions. In normal use, light throttle application will supply

maximum traction. When starting with one rear wheel on an excessively slippery surface, slight application of the parking brake may be necessary to gain maximum traction.

All driving instruments are grouped in the instrument cluster which is located immediately in front of the driver to provide quick reading and maximum convenience and accessibility. The TEMP-PRESS and GEN-FAN indicators provide important information concerning the condition of the engine and should be observed regularly during operation of the car. The information on these pages will help you understand the operation of these instruments. The illustrations here and on page 10 will acquaint you with the instrument cluster and the instrument panel as a whole.

FUEL GAUGE



This electrically operated gauge accurately indicates the amount of fuel in the fuel tank only when the ignition switch is in the ON position. When the ignition is "off", the indicator pointer will not necessarily return to the empty (E) mark, but may stop

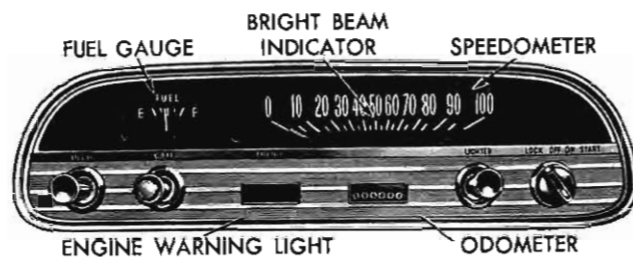

at any point on the gauge. Therefore, always be sure that the ignition switch is "on" before checking the fuel gauge.

SPEEDOMETER

Conveniently located in the instrument cluster directly ahead of the driver, the speedometer shows at a glance the speed of the car in miles per hour. The odometer, centered directly below the speedometer dial registers accumulated vehicle mileage.

TEMP-PRESS AND GEN-FAN INDICATORS

These indicators provide a check on the operating condition of the engine and the generator. Both indicators should light with the ignition switch ON before starting the engine and should go out after the engine is started. The lights should remain out while engine is operating, except the GEN-FAN indicator may flicker when engine is idling. If car is equipped with air conditioning see page 15 for additional information.

CAUTION: If either of these indicators light while car is being driven, immediately follow the procedure outlined under "EMERGENCY OPERATING INSTRUCTIONS," so car may be driven to the nearest service facility.

EMERGENCY OPERATING INSTRUCTIONS

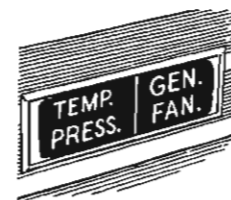

(To be followed if either TEMP-PRESS or GEN-FAN indicators light while car is being driven.)

1. Set heater FAN and HEAT controls to full "ON" and AIR controls to "OFF" positions.

(If equipped with air conditioning, turn air conditioning FAN switch to OFF.)

NOTE: After setting the heater controls, leave them in that position until cause of trouble is corrected.

2. Stop the car as soon as driving conditions permit. Turn ignition key to OFF to stop engine but turn key back to ON so heater blower will continue to cool engine.
3. Check for broken fan belt or belt off pulleys or engine low oil level. If only GEN-FAN indicator is lighted, belt is not broken or off pulleys and engine oil level is satisfactory, car can be driven at slow speeds; however, generator must be checked and serviced as soon as possible.
4. If trouble is found to be a broken fan belt or belt off pulleys, wait approximately five minutes, start engine and drive car at no more than 25 miles per hour until TEMP-PRESS indicator comes on, then repeat Step 2.

NOTE: The GEN-FAN indicator will stay on until fan belt is installed.

5. Repeat Step 4 as necessary until facility is reached where fan belt can be installed.

CONTROLS

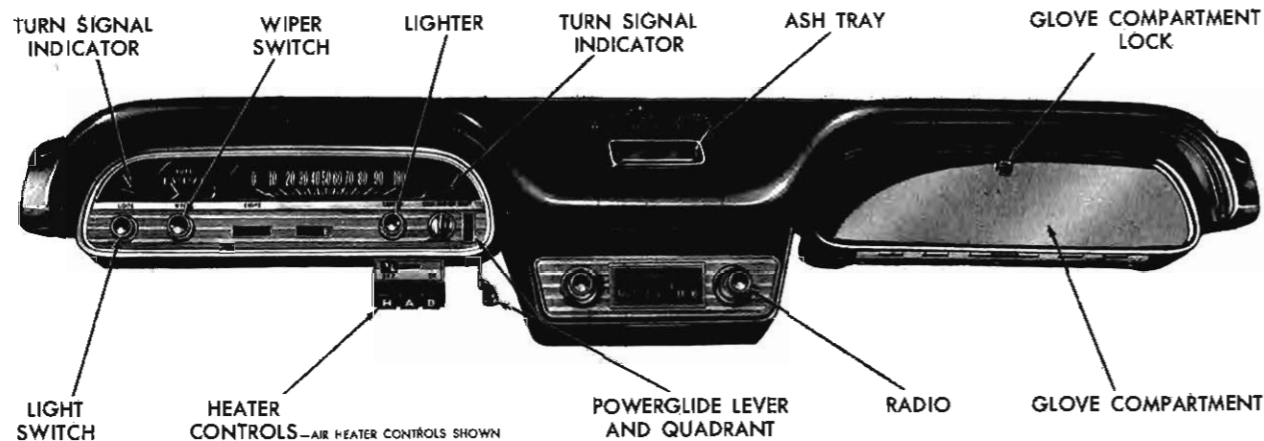

LIGHT CONTROL KNOB

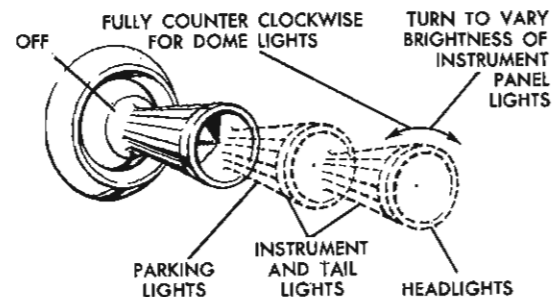

The three-position light switch is operated as shown. Turn the knob to vary the brightness of the instrument lights. Turn the knob fully counterclockwise past the "detent" to turn on the dome light. The headlamp and parking lamp circuits are protected by a circuit breaker. An overload condition will cause the headlights to "flicker" on and off. If this flickering condition is experienced, the head lamp circuit should be checked by your Authorized Chevrolet Dealer.

DIMMER SWITCH

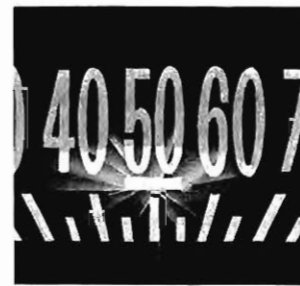
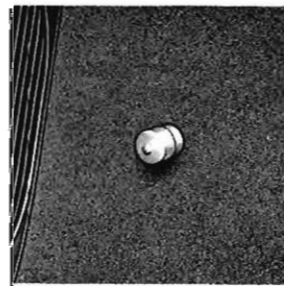

The foot button switches the headlights between "high" and "low" beam. The red "high" beam indicator will be lighted when the headlights are on "high" beam. Always dim the lights when approaching oncoming cars.

LIGHTING SYSTEM TROUBLE CHECKS

- If headlights flicker, your Authorized Chevrolet Dealer should be called upon immediately to correct the overload condition.
- If the tail light fuse blows out, the instrument panel lights will also be inoperative. Check both the instrument panel fuse and the tail light fuse. (See Specifications.)
- If, when signalling a turn, the green turn signal indicator comes on but does not flash, a burned out front or rear turn signal lamp on that side or an im-

TURN SIGNAL

The turn signal lever should be moved UP to signal a right turn or DOWN to signal a left turn. The green turn signal indicators in the instrument panel will signal the direction as will the front and rear turn signal lamps. When the turn is completed, the lever will automatically return to neutral position.

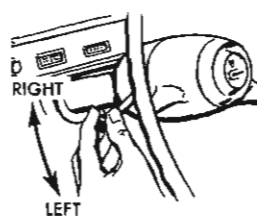

Get into the habit of turning on the signal well in advance of where you plan to turn. Drivers who are following will appreciate your consideration.

FOOT CONTROLS

Foot controls consist of the dimmer switch (the operation of which is covered on page 11), the clutch pedal (manual transmissions only), the brake pedal and the accelerator pedal.

CLUTCH PEDAL

The operation of the clutch pedal has been fully covered under "Driving with the Manual Transmissions" on page 4. Its operation is the same whether your car is equipped with the 3-speed or the 4-speed transmission. Excessive clutch wear can be caused by letting up the clutch abruptly rather than smoothly, and by "riding" the clutch—that is, letting your foot rest on the clutch while driving.

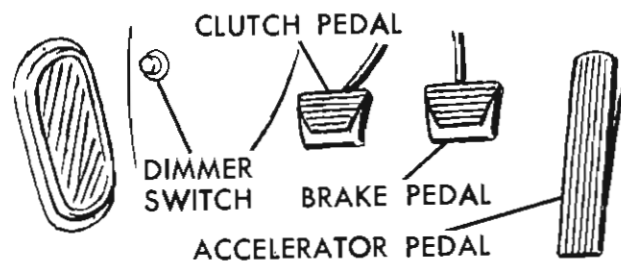

BRAKES

The brake pedal should have a hard firm feel when applied. If the pedal feel becomes soft or spongy the brakes are in need of service. Your Chevrolet Dealer can return your brakes to safe operating condition.

Vehicles equipped with optional metallic brake lining will require somewhat more pedal pressure to stop the car when the linings are cold than will conventional brakes. This condition will exist only until several stops are made so the linings warm up.

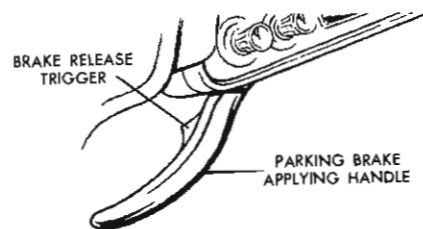

Pull the parking brake lever to engage the brake. The lever will remain in the applied position until released by means of the "trigger" on the handle. To release, pull the handle toward the steering wheel, depress the unlocking trigger and allow the handle to return to the released position. Always engage the parking brake when parked.

WINDSHIELD WIPERS AND WASHERS

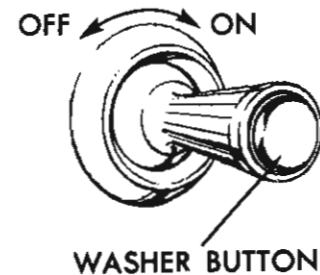

The single-speed (or optional two-speed) parallel acting wipers are operated by means of the wiper control knob on the dash. Turning this knob clockwise turns on the wiper motor. The optional two-speed wipers have three switch positions, "Off," "Low" and "High." A fully counterclockwise turn of the knob turns off either wiper.

Exposure to the "elements" tends to "wear out" the rubber in the wiper blades. Check the blades periodically and replace them whenever they show signs of streaky or otherwise poor wiping action.

Pressing once on the accessory windshield washer button will cause the washer to squirt a measured amount of water or other cleaning agent onto the glass and will at the same time turn on the wiper. The wiper must then be manually turned off, when the washing process

is completed, by means of the wiper control knob.

Water or cleaning agent needed for operation of the accessory windshield washers is carried in a plastic water jar attached to the dash panel within the luggage compartment. Keep the washer jar filled to a level 2 inches below the top of the jar with a suitable solvent. Windshield Washer Anti-Freeze and Solvent, G. M. Part No. 988299, is recommended for use in the Corvair windshield washer jar. NEVER USE ANY SOLVENT OR ANTIFREEZE SOLUTION WHICH CONTAINS METHANOL. In the winter, fill the washer jar only $\frac{3}{4}$ full to allow for expansion if the solution freezes. In freezing weather, pre-warm the windshield using the heater defrosters before using the washers.

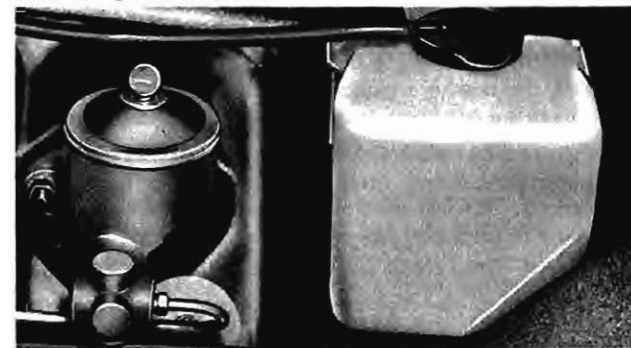

DIRECT AIR HEATER

The Direct Air Heater makes use of engine cooling air to heat the interior of the car. The controls are:



FAN—Controls blower speed. Blower must not be operated unless **HEAT** or **AIR** lever is depressed.

AIR—Controls the amount of moderately heated air presented to the heater system.

HEAT—Controls the amount of hot air to the system.

NOTE: When shutting off either of the above control levers, pull fully up until the lever snaps into the latch position.

DEF—Diverts heated air to the defroster outlets.

OPERATION FOR MAXIMUM COMFORT

- **MINIMUM HEAT REQUIREMENTS**—During spring and fall in areas where climatic conditions are less severe, depress the **AIR** lever only as required for your comfort.
- **MEDIUM HEAT REQUIREMENTS**—Depress the **AIR** lever all the way down, then depress the **HEAT** lever as required. This will control the flow of mixed air (moderately heated and hot air) necessary for temperature

NOTE: In Direct Air Heaters water vapor and odors may collect when vehicle stands for long periods, keep the **HEAT** and **AIR** levers in **OFF** position for first few minutes of engine operation. This will reduce the tendency for moisture to condense on windshield and will reduce odors entering passenger compartment. Windshield fogging at start of defroster operation may be corrected by opening vent windows. Oil spilled on engine shrouding may cause odor in passenger compartment. To avoid discomfort, the cause of any odor should be traced and any defect promptly corrected.

control and provide definite variation of air temperature.

- **MAXIMUM HEAT REQUIREMENTS**—Depress **HEAT** and **AIR** levers to extreme down position. If heat becomes excessive, pull up **HEAT** knob to desired position.

GASOLINE HEATER



The optional Corvair gasoline heater provides an ample volume of heated air within two minutes after being turned on; controls are:

FAN—This lever provides "LOW" blower speed at its first stop and "HI" blower speed when in the full down position; it must be pushed down to either position before heater will operate.

DEF—Diverts heated air to the defroster ducts for defogging or deicing windows; depress to increase flow.

HEAT—Depress lever to select degree of heat desired.

NOTE: It is a normal condition for combustion blower to operate a short time after heater or car ignition is turned off.

AIR CONDITIONING

Optional air conditioning provides all-weather comfort while driving your Corvair. This re-circulating type unit has two knobs to provide control of cool air flow. The air flow can be directed through the two front ball outlets and the center outlet bezel.



The air conditioning controls function as follows:

FAN—Rotate knob to provide the desired blower speed, low, medium or high. The fan will operate no higher than **MED** speed when headlights are on.

COOL—Pull knob fully out to provide maximum cooling. Intermediate positions provide moderate cooling.

Always operate the Air Conditioning System with all windows and vents closed to eliminate drafts, wind and road noise. Cover plates furnished should remain installed over the two engine air recirculating slots during the season when cooling is required. These plates should be removed and stowed on top of the rear sill for the winter.

CAUTION: Momentary engine overheating may occur if air conditioner is being operated during extended periods of long uphill pulls or during extreme outside temperatures. If either the **GEN-FAN** or **TEMP-PRESS** indicators remain lighted while car is being driven, turn off air conditioner and follow the procedure presented under "EMERGENCY OPERATING INSTRUCTIONS" on Page 9.

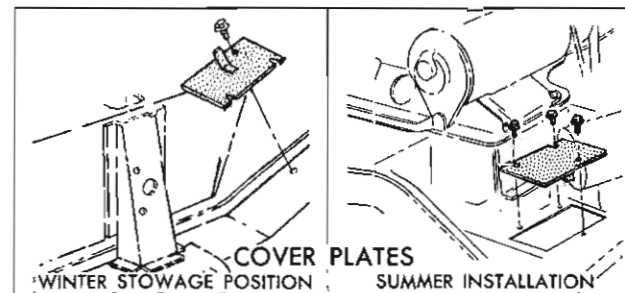

CHEVROLET RADIOS

The optional "all transistor" Chevrolet Radios differ mainly in their operating controls which are reviewed here.

Manually Tuned Radio

RIGHT CONTROL KNOB—The right control knob is used for manual selection of radio stations. The wing knob at its base controls the optional rear seat speaker.

LEFT CONTROL KNOB—The outer knob serves to turn the set on and off and to control the volume. The "wing knob" at its base may be moved to change the tone from treble (extreme clockwise) to bass (extreme counterclockwise).

This control is designed to give highest tone fidelity when positioned at the midpoint between the treble and bass settings.



Push Button Radio

The push button radio has the manual tuning control knobs plus push buttons which automatically select preset stations when pushed in.

To preset the push buttons:

1. Warm up the radio for 10 minutes (20 minutes in freezing temperatures).
2. Pull the push button straight out as far as it will go.
3. Tune the desired station manually.
4. Push the button all the way in.
5. Check operation of push button and repeat Steps 2 through 4 if tuning is not accurate.
6. Repeat this procedure for each push button.



RADIO TIPS

- Be sure your dial is exactly on the station for clearest reception.
- For local reception, raise the antenna at least as high as the roof of the vehicle. For long distance reception, extend the antenna to its full length.
- Push buttons may need to be readjusted occasionally for best reception.
- The Conelrad markings at 640 and 1240 on the radio dial indicate Office of Civilian Defense frequencies; the only frequencies which will be used in case of a national emergency.
- If radio stops playing, first check the radio fuse in the junction block; then check the antenna lead-in cable. If this does not locate the trouble, take the radio to your Authorized Chevrolet Dealer.

CIGARETTE LIGHTER AND ASH TRAY

Press in on the optional cigarette lighter to heat. When ready for use, it will "pop" out. The ash tray cover slides toward the front of the car to open. The ash receptacle lifts out for cleaning.



AIR VENTS

Additional summer ventilation is provided through vent inlets in each side of the front passenger compartment. The vents may be opened or closed by means of the control knobs beneath each end of the instrument panel.

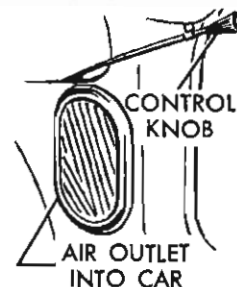

KEYS

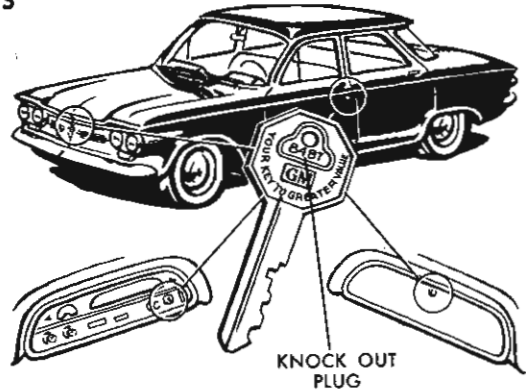

A single key operates all the locks on your Corvair; doors, ignition switch, glove box and luggage compartment. The optional spare tire lock requires its own key.

Each key has a serial number stamped on a removable plug. This number will provide necessary information to enable you to have another key made in the event that the original is lost.

To avoid the possibility that unauthorized persons might duplicate your key, it is strongly recommended that you record the serial number and then, with a hammer and punch, remove the knockout plug.

DOORS AND LOCKS

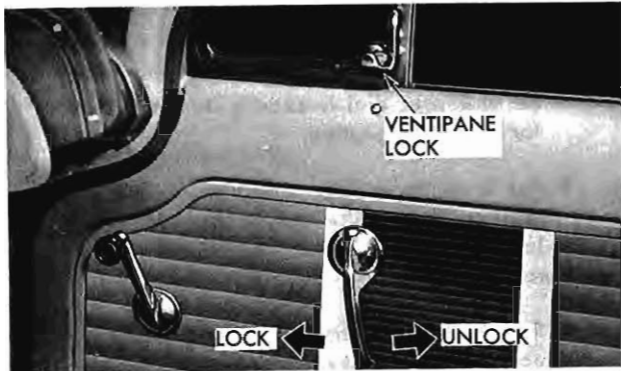

- Each front door may be locked from the outside by means of the ignition key inserted into the key lock just below the door opening handle.
- Lock the front doors from the inside by pushing fully forward on the inside release handles. Unlock and open the front doors from the inside by pulling fully rearward on the release handle.
- Open the ventipane windows by lifting up and forward on the friction latches. Pushed out, the window will remain in the desired position.

REAR DOORS

- Rear doors, on 4-door models are operated from the outside by means of a push button door handle in the same manner as the front doors. No key lock is provided on the outside of either rear door.
- The inside release handle pulls to the rear to open the rear doors in the same manner as the front doors but is not used to lock the doors.
- Lock the rear doors from inside by depressing the locking button in the window sill. When this button is depressed, both the inside and outside door handles are inoperative. This button must be raised before the doors can be opened either from the inside or outside. This feature becomes very important when young children ride in the rear seat.



SEATS



Front Seat Adjustment

The one-piece front seat of Corvair 500 and 700 models is easily adjusted forward or rearward to provide maximum driving comfort.

To adjust the seat, move the control lever on the driver's end of the seat rearward. Then by exerting slight body pressure the seat may be moved forward or rearward. When the lever is released, the seat is automatically locked in position.

The Monza bucket seats—driver's seat and passenger's seat alike—are adjusted in exactly the same manner. The seat control lever for each seat is located beneath the outer edge of the seat (toward the door). Move the lever rearward to unlock the seat, release the lever and the seat is locked in the desired position.

Your Authorized Chevrolet Dealer can make additional adjustments to tailor front seat positioning to your particular comfort requirements.

Folding Rear Seat

The folding rear seatback, standard equipment on Monza and optional on all other Corvair models except convertible, quickly and easily folds forward and down to provide additional cargo space in four-door sedans as well as in coupe models. The folding seat in both models operates in exactly the same manner except that the four-door models include a folding panel at the bottom of the seatback which must be "snapped" into or out of place after lowering and before raising the seatback.

CAUTION: If the car has rear door armrests it will be necessary to open both rear doors before raising or lowering the rear seatback.

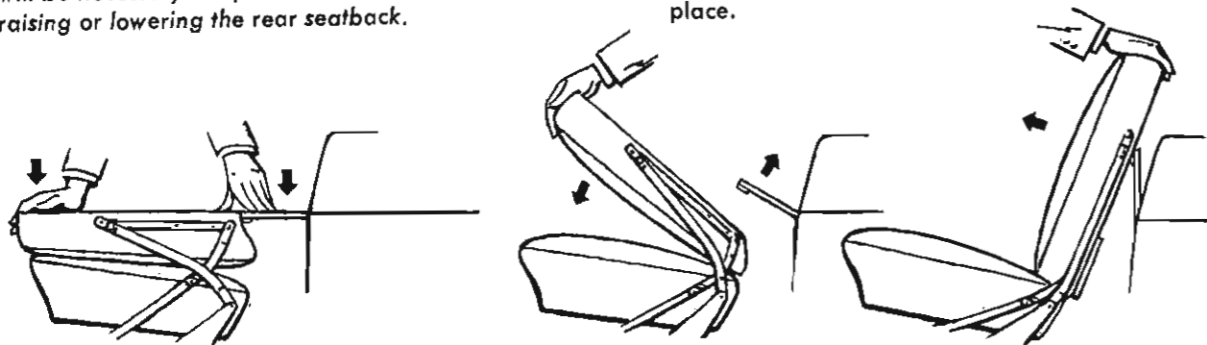

FOLDING REAR SEAT

To lower the folding seatback:

- Pull on each end of the seatback to unlock.
- Swing the seatback forward and down.
- On four-door sedans, press down on the front edge of the lowered seatback with one hand while "snapping" the folding panel, at the bottom of the seatback, into place.

To raise the seatback:

- On four-door sedans, press down on the front edge of the seatback and "unsnap" the folding panel.
- On all models, lift the seatback and slam firmly into place.

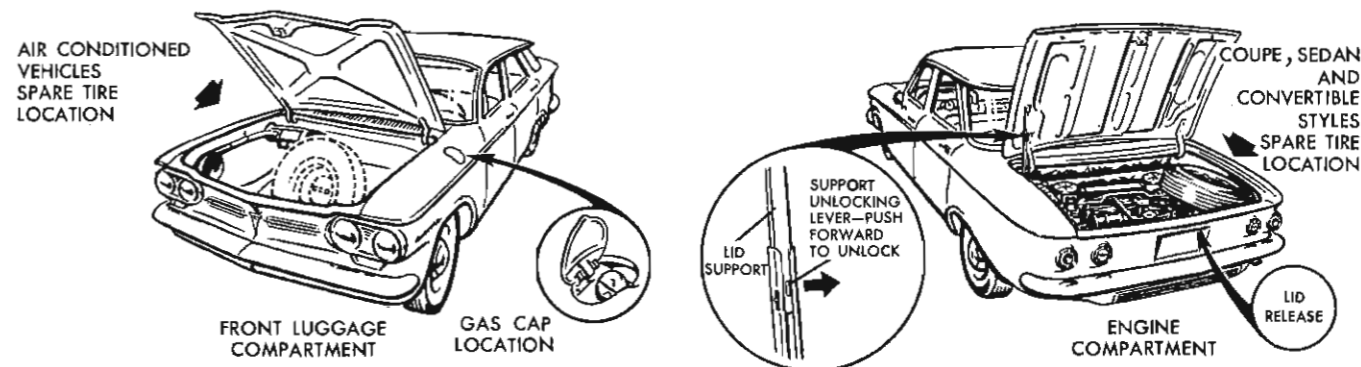

LUGGAGE COMPARTMENT

The luggage compartment is located beneath the lid at the front of the car.

- To open the luggage compartment, insert the ignition key and, holding the lid down to relieve the tension on the lock, turn the key fully clockwise and allow the counterbalanced lid to open.
- To close, slam the lid firmly.

A second luggage space is located behind the rear seat, for porcel or luggage which would otherwise take up seat or floor space.

GAS CAP

The gas cap is concealed beneath the spring loaded door on the left front fender.

ENGINE COMPARTMENT

- To open: Push up the lid release while lifting the lid. Lift the lid all the way up, then release.
- To close: Lift up on lid, unlock the support arm catch lock, then lower the lid. Drop the lid the last six inches to assure that the lid lock mechanism is engaged.

For proper engine cooling keep the engine compartment lid vents free of ice, snow and leaves.

CORVAIR SPYDER

The turbocharged engine of your Spyder model is special—and looks it. Under no conditions should the Turba-Supercharger be removed and installed on another car. Your Corvaïr Spyder is designed around the Turbo-Supercharger and all the related parts are necessary.

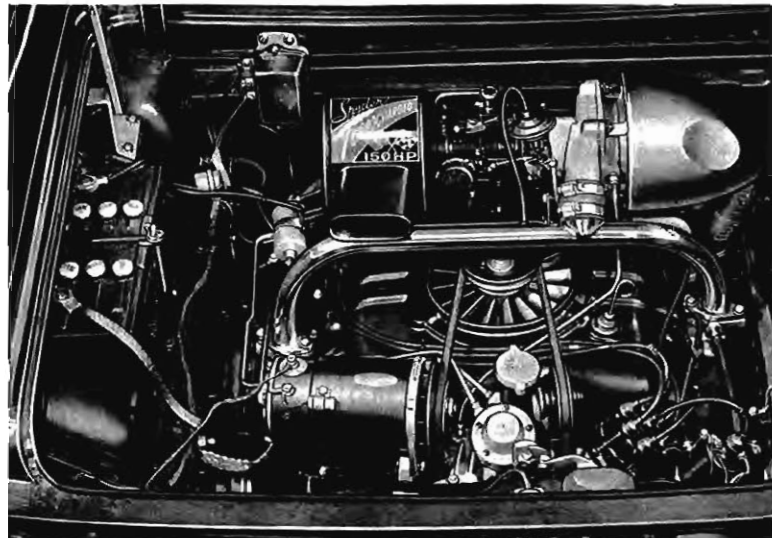

Break-In Period—We recommend that the supercharger not be used for the first 500 miles. Keep engine speed below 2500 rpm to maintain negative readings on the Manifold Pressure Gauge. From 500 to 1000 miles, short bursts are permitted but not sustained runs. After the first 1000 miles, the car may be driven to take full advantage of the extra power from the supercharger.

Fuel and Engine Oil Requirements—Refer to "Maintenance and Lubrication."

Air Recirculating Plates—These plates, the same as used on Air Conditioned Corvaïrs, should be installed in the summer and removed in the winter as shown on Page 15.

Detonation—Caused by low grade fuel, faulty timing, carbon deposits or an over-filled crankcase, this condition is more serious than on other engines. If detonation occurs, have your car checked by your Chevrolet Dealer.

YOUR CORVAIR SPYDER INSTRUMENT PANEL

We feel that you, as owner of the Corvaïr Spyder, will be more interested in a constant check on engine operation than would the average driver. Therefore the following instruments have been provided for your use and information.

Tachometer—with a range of 6000 rpm. Upshifts can be made up to 5300 rpm. Downshift as desired provided engine speed in new gear does not exceed 5300 rpm. The red line at 5500 rpm indicates recommended maximum engine speed.

Speedometer—maximum reading of 120 mph. Odometers are provided for both trip and cumulative mileage. Set the trip odometer by means of the knob located beneath the instrument panel and to the left of the steering column.

Temp-Press and Gen-Fan Indicators—operate in the same manner as on other Corvaïrs. In addition, a warning buzzer connected to the temperature light will operate if engine temperature reaches the danger point. Under extreme operating conditions, momentary engine overheating may occur. Should the Temp-Press light

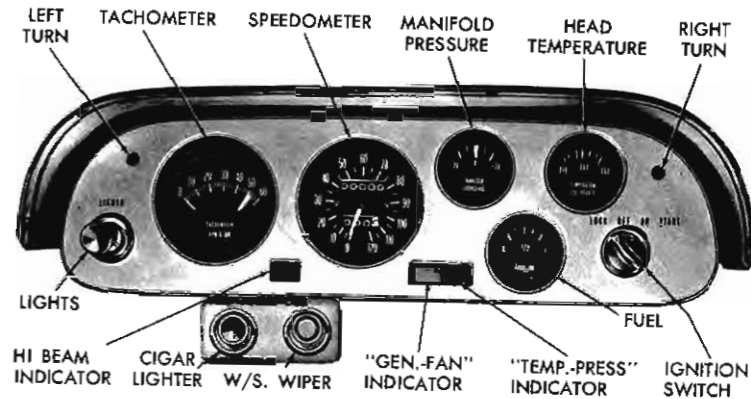

come on, release the throttle and, if the light stays on, follow the instructions presented on Page 9.

Manifold Pressure Gauge—tells when the supercharger is functioning. Negative readings indicate normally aspirated engine operation. Positive readings indicate that the supercharger is building up pressure far more power.

Cylinder Head Temperature Gauge—indicates cylinder head temperature to warn of approaching overheat condition.

CORVAIR 95



RAMP SIDE



GREENBRIER SPORTSWAGON



CORVAN

INSTRUMENTS AND CONTROLS

The Corvaire 95 instruments and controls are essentially the same as those of the Corvaire which are described in preceding pages of this book. However, due to body construction, various items differ somewhat in operation and location. The next few pages cover those items peculiar to the Corvaire 95 only.

The light green dots with black numbers which appear just below the speedometer dial indicate the recommended speeds at which the optional 4-speed transmission should be shifted into 2nd, 3rd and 4th gear.



Information concerning the operation of the four speed transmission will be found in the manual transmission operating instructions on page 4.

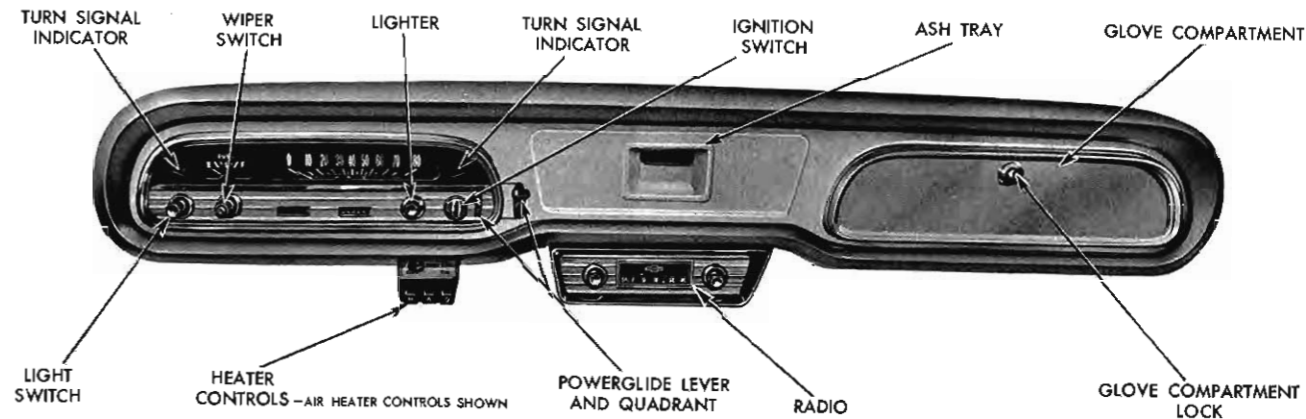

FOOT CONTROLS

Foot controls, illustrated below, are operated in the same manner as those of the Corvaire.

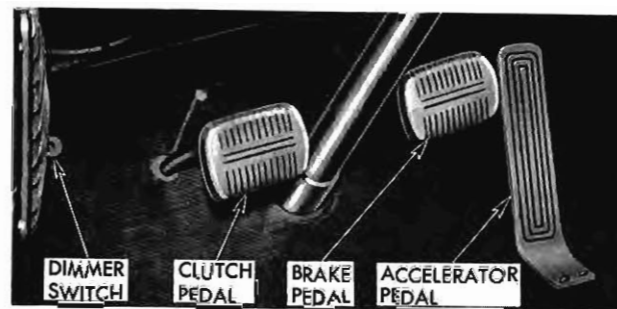

WINDSHIELD WASHERS

Water or cleaning agent needed for operation of the accessory windshield washers is carried in a plastic water bag under the dash panel. It is attached to the cowl by three hooks. To fill with water or solvent: remove the bag from the hooks, drap to where the cap may be unlocked and removed, fill the bag, replace the cap and reinstall on the three hooks.



ASH TRAY

The ash tray will pivot out when the handle is pulled.

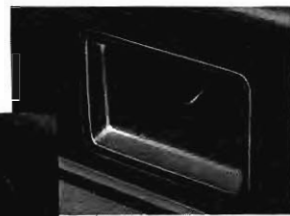
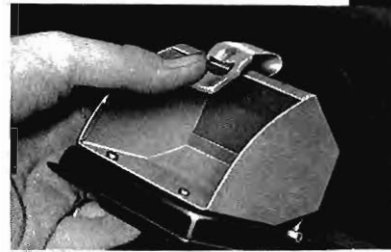

To remove the ash tray, depress the tab and lift out.

ENGINE COMPARTMENT ACCESS

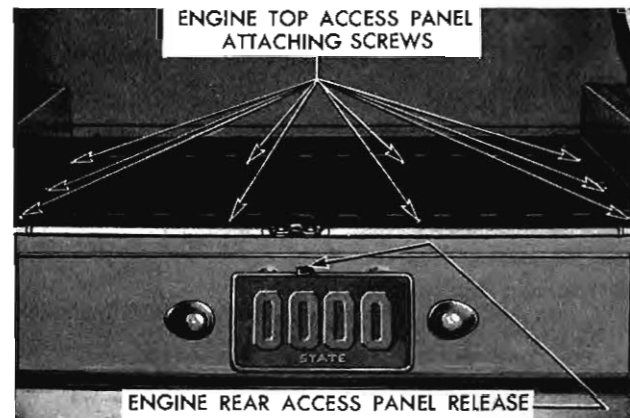

DOORS AND LOCKS

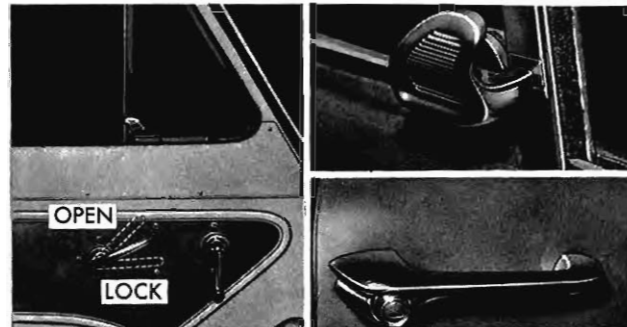

Both front doors may be locked from the outside by means of the ignition key inserted into the push button in the door handle. Turn the key clockwise to lock, counter-clockwise to unlock. Both doors may be key locked while open, and when closed, they will remain locked.

Lock the front doors from the inside by pushing fully forward on the release handles. Unlock and open the doors from the inside by pulling fully rearward on the release handles.

The ventipane window friction locks are simply lifted up and forward to unlock and the pane pushed out to the desired position.

DOUBLE SIDE DOORS

FRONT SIDE DOOR — Open from the outside by turning the handle downward and from the inside by pulling to the rear on the inside release handle.

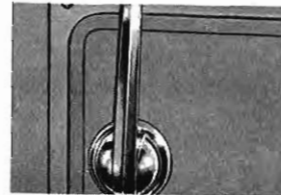
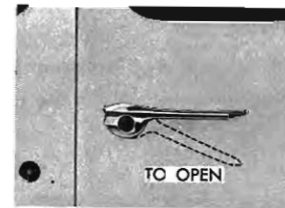

REAR SIDE DOOR—Open (after the front side has been opened) by means of the release handle located on the inner door panel.

LOCKING THE SIDE DOORS

—After both side doors are closed, they may be locked from the inside by means of the push button located on the foremost part of the window sill. The lock is conveniently located for accessibility by the driver. Visual indication precludes the necessity of checking operation of the doors to see if they are locked.



DOUBLE REAR DOORS

The rear doors operate in much the same manner as the side doors, but lock and unlock at the door handle push button release only. No inner door locking mechanism is provided for the rear doors.



FULL DOOR OPENING FEATURE

Special door checks normally permit each side and rear door to open to a maximum of 95°. By removing these checks from their retaining slots in the doors, a full 180° opening of each of these doors is possible. When the doors are closed the check automatically enters its slot in the door thus setting the door for its normal 95° opening.



RAMPSIDE



The rampgate provides convenient, safe and rapid loading and unloading from the curb side of the vehicle.

To Open

- Pull up on the lacking ring located inside the pickup box and to the left of the gate.
- Lift up on both release handles, recessed in the gate inner panel, and *carefully* lower the gate to level ground.



To Close

- Carefully lift the gate from the ground and firmly slam to close.

TAILGATE

Open the tailgate by lifting up on both release handles recessed in the inner panel. Slam firmly to close.

SEATS

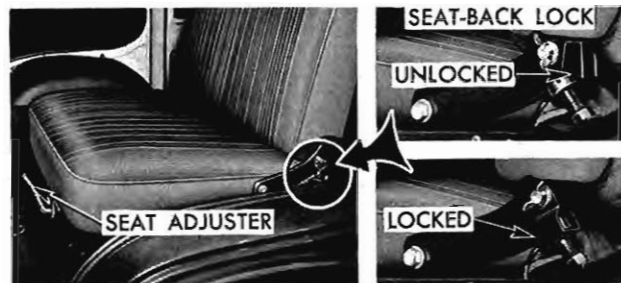

- Adjust the front seat fare and aft by means of the adjuster handle shown. Lift handle up to move seat.
- If desired, the seatback may be adjusted to lean farther forward or backward by means of the bolt and the lock nut shown.
- Adjustment of the seatback lack determines whether the seatback will be rigid or will fold forward. With the seatback lock in the down position, the seatback will not fold forward.



SECOND SEAT

The Greenbrier second seat assembly is factory installed in the back of the rear compartment in the optional third seat position.

If desired the seat may be moved from this position to either a forward or backward seat position. The seat may be changed whenever desired.

An optional third seat is available if desired, but can be mounted only in the third seat position.

If desired, all rear compartment seats may be quickly and easily removed to provide additional cargo space.

To Move Seat

- Remove the proper knock-out plugs from the floor mat after deciding whether, in the second seat position, the

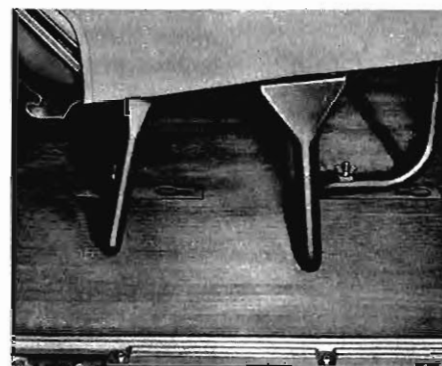

seat is to face forward or rearward. This will expose the mounting slots.

- Loosen the wing nuts attaching the front legs of the second seat to the floor and slip the balt heads rearward out of the retaining slots.
- Move the seat to the desired position, unfold the rear leg and slide the four balt heads into the slots and tighten the wing nuts.

FUEL FILLER CAP

The fuel filler cap is located below the rear of the driver's door.

CLEANING HINTS

EXTERIOR APPEARANCE

Your Corvair is finished with General Motors "Magic-Mirror" acrylic lacquer. This is a finish of maximum beauty which, in depth of color, gloss retention and durability is superior to conventional lacquer finishes.

Washing Your Corvair

The best way to preserve the finish is to keep it clean. Normally only frequent washings are required to maintain its original beauty. Wash the car in either warm or cold (never hot) water, not in the direct rays of the sun, and not while the sheet metal surfaces are hot. Never wipe dirt from dry painted surfaces because this may scratch the finish. The use of strong soaps and chemical detergents should be avoided and in any event cleaning agents should be promptly flushed from the surface and not allowed to dry or they may streak the finish.

Polishing and Waxing Your Corvair

Even though the acrylic paint on your car is more durable than conventional finishes, under certain conditions you may wish to wax or polish your car to provide maximum protection. Calcium chloride and other salts, road oil and tar, tree sap, chemicals from factory chimneys and other foreign matter may damage any known automobile finish if allowed to remain in contact with the paint film. Prompt washing may not thoroughly remove

these deposits and, particularly in geographical areas where these exposure conditions are severe, properly applied polishes and waxes of known quality will provide the best protection. Chevrolet Dealers offer G. M. Acry-Mel Hand Applied Cleaner and Polish (G. M. Part Number 985090) and G. M. Triple Action Cleaner and Polish (G. M. Part Number 986085); both are excellent for use on acrylic finishes. Road oil and tar removers must be warranted safe for use on acrylic finishes. Chevrolet recommends G. M. Road Oil and Tar Remover (G. M. Part Number 987782).

Protection of Exterior Bright Metal Parts

All bright metal parts of the car should be regularly cleaned and protected against the same substances harmful to the painted surfaces. Normally, washing with water is all that is required. However, G. M. Chrome Polish may be used on CHROME or STAINLESS STEEL trim if necessary. Never use chrome polish, steam or any caustic soap to clean ALUMINUM. Wash only with lukewarm water, and if necessary, a mild soap. Rinse well and dry thoroughly. Severe cases may be cleaned with a cleaning compound specified for acrylic finishes.

It is recommended that all bright metal parts of your Corvair, after being thoroughly cleaned, be given a coating of wax and rubbed to a high polish. This will serve to keep corrosive agents away from these surfaces, and should be repeated as often as required.

Cleaning White Sidewall Tires

Use soap, warm water or a tire cleaner such as G. M. Whitewall Tire Cleaner (G. M. 987475) and a stiff brush to remove road grime and dirt from white sidewall tires. A fine grade of steel wool will remove severe curb scrapes. Do not use gasoline, kerosene or any oil product which would discolor or deteriorate the rubber.

CAUTION: Some white sidewall cleaners will cause serious damage to aluminum trim. Use caution when cleaning tires with this type of cleaner. G. M. Whitewall Tire Cleaner is safe to use around aluminum trim.

CORVAIR MODELS

BRIGHT METAL TRIM—TYPE AND LOCATION

ALUMINUM	Headlight Frames Parking Light Frames Tail Light Frames Backup Lamp Frames or Cover Plate Exhaust Grille Panel
CHROME	Body Front Panel Molding Bumpers Front Emblem Push Button Door Handles Door Key Locks Nameplates Ventipane Frame
STAINLESS STEEL	All bright metal trim not listed above may be assumed to be stainless steel.

INTERIOR APPEARANCE

Dust and Dirt

Clean the interior of your car frequently, using a broom or vacuum cleaner. A damp cloth will wipe dust from hard surfaces. G. M. Leather Cleaner (G. M. Part 987476) is available from your Authorized Chevrolet Dealer to clean any imitation leather, vinyl or coated trim fabric on seats or door panels.

Spots and Stains

Remove upholstery stains as soon as possible or they may become "set" and difficult or impossible to remove. First determine the type and age of the stain and the kind of upholstery material. Kar Kleen Upholstery Cleaner (G. M. 987611) or Kar Kleen Upholstery Spot Cleaner (G. M. 987272), available from your Authorized Chevrolet Dealer, will remove most stains. For oil, grease and road grime stains not removed by these cleaners the use of a volatile type cleaner such as G. M. Upholstery Spot Remover is recommended. Do not use alkaline cleaners for they may damage the color or finish of the materials. Other solutions such as hot or cold water, ammonia water, soap, ink eradicator, etc., will probably discolor and disturb the material.

OCTANE REQUIREMENTS

The Corvair Turbo-Air six cylinder engine is designed to deliver peak performance on what is designated as Regular grade fuel in the United States and Canada.

The Monza Model with Powerglide, the Turbo-Supercharger equipped Spyder and all Corvairs equipped with the Super Turbo-Air engine are designed to operate most efficiently on Premium gasoline.

Regular gasoline may, however, vary in octane between manufacturers or between different sections of the country. If unfavorable performance is encountered because of either or both of the above factors, any Authorized Chevrolet Dealer can make ignition adjustments which will restore your car to normal operation.

Operation in Foreign Countries

If you plan to operate your Corvair outside the continental limits of the United States or Canada, there is a possibility that the best fuels available are so low in octane quality that excessive knocking and serious engine damage may result from their use. To minimize this possibility, write to Chevrolet Motor Division, General Motors Corporation, Service Operations Department, Detroit 2, Michigan giving:

- The compression ratio of your engine (refer to Specification Section in this booklet.)
- The car identification number (obtain from car registration or title).

- The country or countries in which you plan to travel. You will be furnished details of adjustments or modifications which should be made to your engine, by your Chevrolet dealer prior to your departure. Failure to make the necessary changes to your car and subsequent operation under conditions of continuous or excessive knocking, constitutes misuse of the engine for which the Chevrolet Division is not responsible under the terms of the Warranty.

After arriving in a foreign country, contact the nearest authorized General Motors dealer for brand names of the best fuels available and advice as to where they may be purchased.

ENGINE LUBRICATION

Your car's engine is filled at the factory with a special break-in oil which must be drained after 500 miles when operating in temperatures of 60° F. and higher, and refilled with oil of the viscosity shown in the chart.

LOWEST ANTICIPATED TEMP.	RECOMMENDED SAE VISCOSITY OIL	
	SINGLE VISCOSITY	MULTI-VISCOSITY
32° F.	SAE-30	SAE-10W-30
-10° F.	SAE-10W	SAE-10W-30
Below -10° F.	SAE-5W	SAE-5W-20

The use of a high quality oil of the correct viscosity is your best assurance of continued reliability and per-



formance from your engine. It is recommended that you use an oil which, according to the label on the can is (1) intended for service MS and (2) passes car makers' tests or meets General Motors Standard GM 4745-M. Your serviceman will be pleased to assist you in selecting the proper oil for your car.

Check the oil level on the dipstick frequently. The level should be somewhere between the "add oil" and "full" marks on the dipstick. Do not overfill. Poor performance and possible engine damage may result if the crankcase is overfilled. Drain and refill the crankcase every 6000 miles or 60 days, whichever occurs first.

NOTE: When checking or adding oil, be careful to avoid spilling or dropping oil onto the engine shrouding.

COOLING SYSTEM CARE

The Corvair engine, being an air cooled engine, is

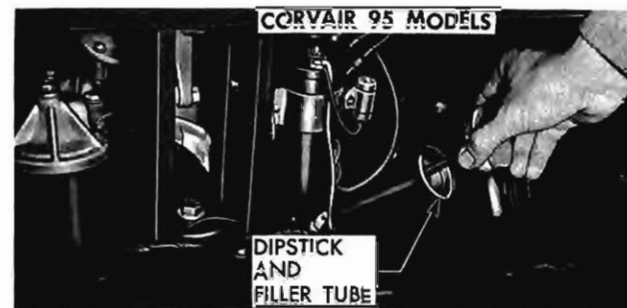

entirely dependent on the fan belt and blower to supply sufficient volume of air for cooling purposes. The engine fan belt should be checked for tightness at regular intervals and replaced when necessary. Watch the TEMP-PRESS and GEN-FAN indicators on the instrument panel for signs of engine overheating.

The engine air inlet louvers are located in the engine compartment lid on Corvair and Spyder models or in the upper rear quarter panels on Corvair 95 models. Since these louvers supply all of the engine combustion and cooling air as well as air for the Direct Air Heater, care should be taken that they are never sealed or blocked.

BATTERY CARE

Check fluid level frequently. Keep filled with distilled water to level of split ring in vent tube.

TIRE CARE

Your new Chevrolet Corvair is designed to operate most efficiently with the inflation pressure shown in the following table. Nothing will be gained by exceeding pressure shown, whereas, excessive pressures can adversely affect riding comfort and quietness. Under inflation affects vehicle handling and tire life. Over-steer problems may also be encountered with incorrect pressures. Maintain recommended pressures at all times.

All four wheels of your Corvair have been static-balanced for best performance and tire life. Wheels should be rebalanced after tire service or replacement.

TIRE SIZE	COLD*		HOT**	
	Front	Rear	Front	Rear
CORVAIR AND SPYDER				
6.50 x 13	15	26	18	30
CORVAIR 95				
7.00 x 14-4 ply S.P.	24	30	28	35
7.00 x 14-6 ply S.P.	24	34	28	39
7.00 x 14-6 ply Light Truck	24	45	28	50
7.00 x 14-8 ply Type	24	60	28	65

Spare Tire—Inflate to proper Rear (Cold) pressure. Deflate to correct pressure when using as front tire.

*After car has been parked for 5 hours or more or driven less than one mile.

**Pressures can rise as much as 5 pounds above cold figures depending on loads carried, length of driving, and car speed prior to check.

FOR MAXIMUM TIRE LIFE

- Keep tires properly inflated.
- Check regularly for cuts, bruises and puncturing objects. Nails etc. will often be carried in the tire with no noticeable loss of air. Do not remove a puncturing object until prepared to change or repair the tire.
- Avoid unnecessary sudden starts and stops; take curves and corners slowly.
- Avoid driving over curbs, sharp objects or chuckholes.
- Have wheel alignment checked periodically, especially when tires show unusual wear.
- Rotate tires periodically as shown in diagram.

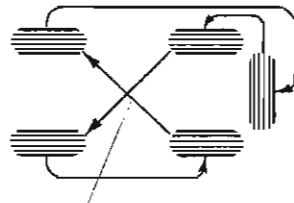

SWITCHING TIRES

Inspection and Repair

Inspect frequently for puncturing objects in the tires. If any are found, do not attempt removal until you are

in a position to change the tire or have it repaired. Also, check regularly that the wheel rim has sustained no damage which could affect the air seal.

SPARE TIRE AND JACK STOWAGE

Spare tire and jack stowage for the different styles are illustrated below.

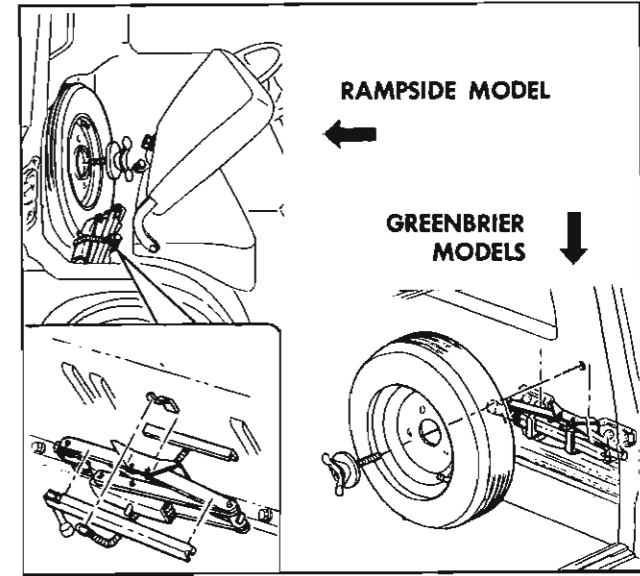
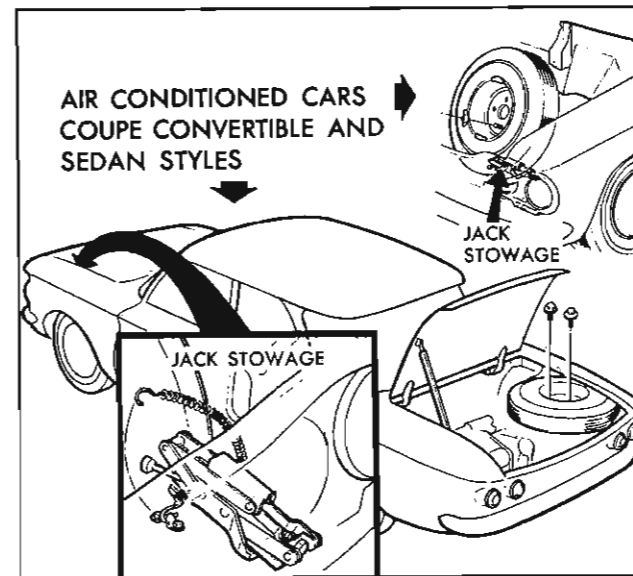

Jacking the Car

The scissors type jack and its wrench are stowed in the different models as illustrated. The opposite end of the wrench is shaped into a "finger" designed for use in removing the hub caps.

CAUTION: Never attempt to raise the Corvaire by placing any kind of jack under the bumper.

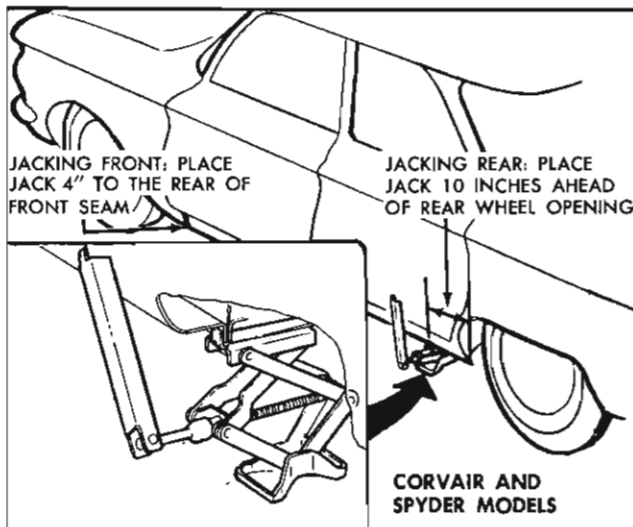

When jacking the car, set the hand brake, block diagonal wheel, and, if changing wheels, remove the hub cap and loosen wheel nuts. Place the jack under the side of the car located as shown.

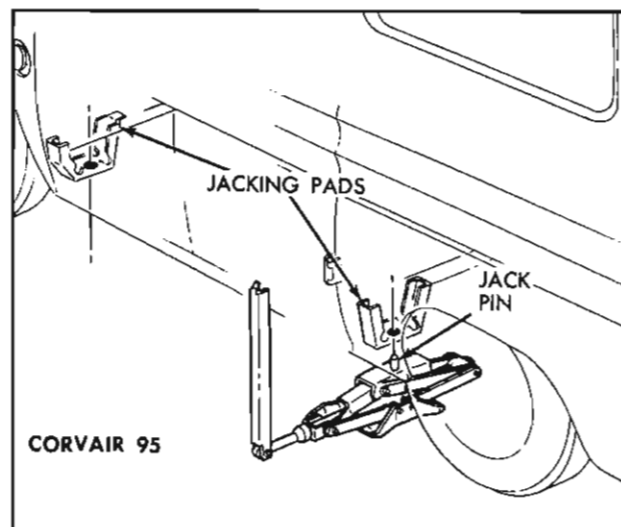

PERIODIC MAINTENANCE AND LUBRICATION

The time or mileage intervals on the following pages are intended as a general guide for establishing regular maintenance and lubrication periods for your Corvaire. Sustained heavy duty or high speed operations or operation under adverse conditions may necessitate more frequent servicing. For specific recommendations for conditions under which you use your vehicle, consult your authorized Chevrolet Dealer.



ENGINE OIL CHANGE*

See "Engine Lubrication" in previous pages.

OIL FILTER*

Change the filter element every 6000 miles or every six months, whichever occurs first.

CRANKCASE VENTILATION VALVE*

At every oil change the valve should be tested for proper function and replaced when necessary.

STEERING GEAR

Every 6000 miles or 6 months—Remove the filler plug and check to see that the lubricant is at the level of the filler plug hole. If necessary add steering gear lubricant as required.

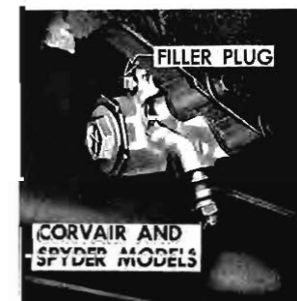

*More often under prolonged dusty driving conditions.

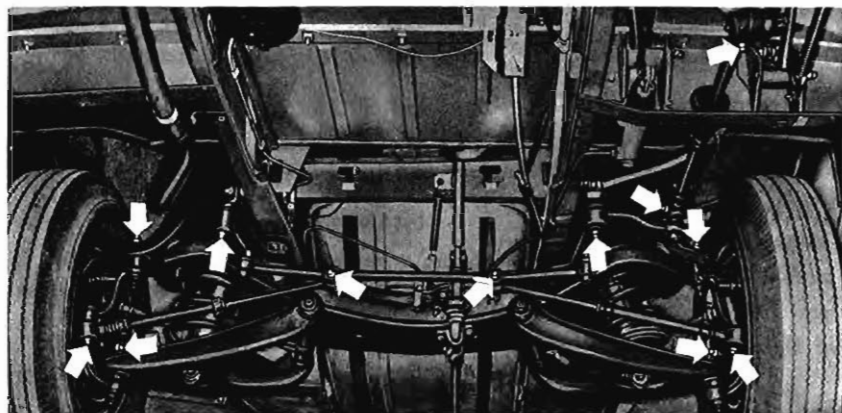

CHASSIS LUBRICANT

Every 6,000 miles or six months lubricate the chassis, at the points listed below, with lubricant specified in Note 1 on page 43.

Corvair and Spyder

Front Suspension—4 Lubrication Fittings

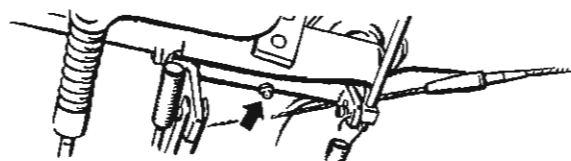

CLUTCH CROSS SHAFT

Steering Linkage—4 Lubrication Fittings

Clutch Cross Shaft—1 Lubrication Fitting

Corvair 95

Front Suspension—4 Lubrication Fittings

Steering Linkage—8 Lubrication Fittings

Clutch Pedal Pivot—1 Lubrication Fitting

Broke Pedal Pivot—1 Lubrication Fitting

Clutch Linkage—Coat the exposed clutch linkage (located just ahead and to the right of the transmission).

GENERATOR

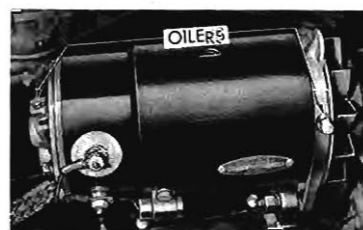

Every 12,000 miles—Fill both oilers with light engine oil. Do not over-oil the oiler nearest fan belt.

DISTRIBUTOR CAM LUBRICATOR

Every 12,000 miles — Rotate cam lubricator 180 degrees. Replace lubricator at 24,000 mile intervals.

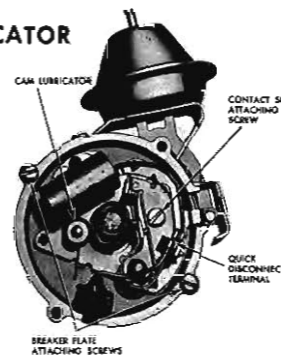

AIR CLEANER

The Corvair Turbo-Air and Super Turbo-Air engines are equipped with two air cleaners, one on each carburetor. Turbocharged engines have one air cleaner. Remove each air cleaner element and service as follows:

Every 6000 miles—Clean and reoil filter element. Under severe dust conditions, it may be necessary to clean and reoil the element more often. To clean: remove element from screen, wash in non-chlorinated cleaning solvent such as kerosene to remove oil and dirt. Squeeze dry, dip in engine oil and squeeze to remove excess oil. (Never shake or wring—always squeeze.) Then wrap element in a clean, dry cloth and squeeze out any remaining oil.



REMOVAL AND CLEANING OF ELEMENT



AIR CLEANER LOCATION

AIR CONDITIONING

Every 6000 miles—Check sight glass, located under the hood, after the system has been in operation for several minutes. Sight glass should be clear. Bubbles or dirt indicate a leak which should be corrected immediately by your Chevrolet Dealer.

Every week—during winter months—run the system 10 to 15 minutes to ensure proper lubrication of the seals and moving parts.

UNIVERSAL JOINTS*

Every 30,000 miles—clean and repack the universal joints with high melting point wheel bearing lubricant.

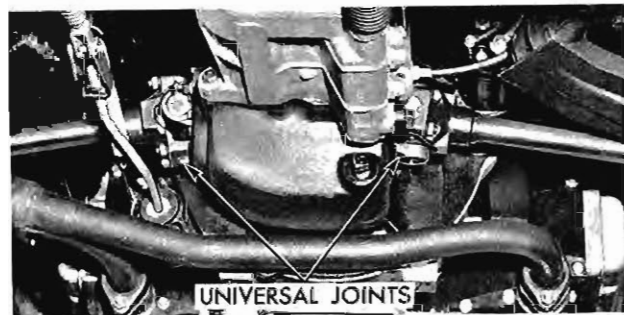

*More often under prolonged dusty driving conditions.

FRONT WHEEL BEARINGS

Every 30,000 miles—Clean and repack bearings with high melting point wheel bearing lubricant. Replace grease seals at the same time.

ENGINE OIL COOLER*

Every 12,000 miles—Remove cover and brush or blow out accumulated dirt.

NOTE: Material usually found in the oil cooler consists primarily of twigs, straw, chaff, and leaves.

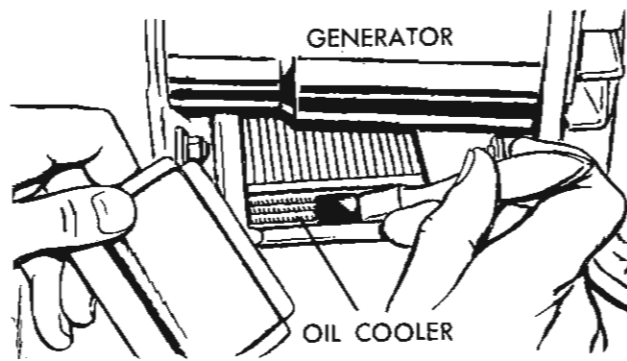

TRANSMISSION—POWERGLIDE

Every 6000 miles—Check fluid level on dipstick, located in the right front of the engine compartment, with engine idling, selector lever in NEUTRAL position, parking brake set and transmission at operating temperature. Add automatic transmission fluid type "A" bearing the mark AQ-ATF, followed by a number and the suffix letter "A", to full mark on dipstick. DO NOT OVERFILL. Correct oil level must be established by dipstick measurement.

Add small amounts of oil, checking the level after each addition, until the proper level is reached.

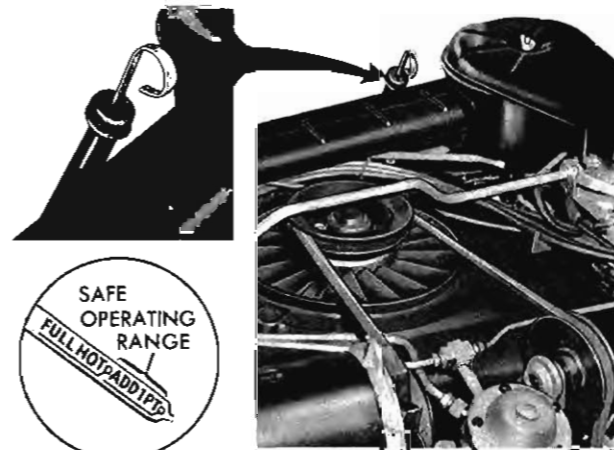

POWERGLIDE DIPSTICK

NOTE: From the "Add Oil" mark to the "Full" mark on the dipstick indicates a difference of only 1 pint of fluid.

If vehicle is so equipped, clean dust and dirt from transmission oil cooler every 12,000 miles. Cooler can be serviced through battery access door.

TRANSMISSION—3 AND 4-SPEED

Follow recommendations given under "Rear Axle".

TRANSMISSION CONTROL LINKAGE—3 AND 4-SPEED

Corvaire and Spyder

Every 12,000 miles—Pull back rubber boot and surround connector (indicated in the illustration below) and the surrounding area with lubricant specified in Note 1, page 43.



Every 12,000 miles—Remove tunnel cover under vehicle and lubricate gearshift lever ball and socket with lubricate.

Corvaire 95

Every 6000 miles—Lubricate the fitting located at the forward end of the transmission control rod with lubricant specified in Note 1, page 43. The fitting is illustrated at the right.



REAR AXLE



Every 6000 miles—Check rear axle at operating temperature and keep lubricant at level of filler plug. If rear axle lubricant is low, check 3- or 4-speed lubricant level also. Keep filled with lubricant specified in Note 2, page 43.

BATTERY

Every 6000 miles—Clean and oil battery terminals and oil felt washer. Clean top of battery with diluted ammonia or soda solution and flush with clean water. Check state of charge especially in freezing weather. An undercharged battery may freeze and break.



Corvaire 95 Battery Access Door

FUEL FILTER

Corvaire and Corvaire 95

Replace filters, located in each carburetor inlet, only if flooding occurs.



Corvaire Spyder

The fuel filter is a separate unit mounted on the air cleaner support bracket at the left of the air cleaner. It should be replaced at 12,000 mile intervals. At the same interval, also clean the screen located in the carburetor inlet.

BRAKE MAIN CYLINDER

Every 6,000 miles—Check fluid level and maintain $\frac{1}{4}$ " below opening with G. M. Hydraulic Brake Fluid Super No. 11.

PARKING BRAKE AND CLUTCH PULLEYS AND CABLES—CORVAIRE AND SPYDER

Every 12,000 miles—Lubricate pulleys under dash. Remove the tunnel cover under vehicle and lubricate

pulleys and cable bearing points with lubricant specified in Note 1, below. Lubricate gearshift lever ball and socket (see page 41) at the same time.

NOTE 1: Lubricate with water resistant EP lube, General Motors Standard GM4751-M.

NOTE 2: Use SAE 80 or SAE 80-90 Multi-purpose Gear Lubricant meeting requirements of U. S. Ordnance Spec. MIL-L-2105B.

BODY LUBRICATION POINTS

Most body lube points do not need frequent, heavy lubrication. However, periodic checks of certain points on the Corvaire body, and lubrication when needed will eliminate annoying squeaks and noises. Be careful not to over-lubricate. Wipe off all surplus lubricant.

The following items should be lubricated periodically:

1. Door Hinges—Wipe off dirt and apply Lubriplate.
2. Door Lock Striker—Wipe off dirt and apply stick type lubricant.
3. Top Lift Cylinder Rods—Clean and lubricate with G.M. Hydraulic Brake Fluid.
4. Door Jamb Switch—Apply Lubriplate (G.M. 987785).
5. Front and Rear Compartment Lid Latch—Apply Lubriplate (G.M. 987785).

6. Front Compartment Lid Torque Rods—Apply G. M. Lubriplate, G. M. Part Number 987785, to bearing points.
7. Gas Tank Filler Door Hinge—Apply driplless oil.
8. Glove Box Door Hinge—Apply driplless oil.
9. Rear Folding Seat Back Support Link Assembly & Filler Panel Hinge—Apply driplless oil to bearing points. The following should be lubricated whenever accessible.
10. Door Outside Handle Lock Cylinder Shaft—Apply Lubriplate (G.M. Part Number 987785).
11. Door Window Regulator and Cams—Apply Lubriplate (G.M. 987785).
12. Door Lock Parts—Apply Lubriplate (G.M. 987785).
13. Door Locking Mechanism—Apply Lubriplate (G.M. 987785).
14. Front and Rear Compartment Hinges—Apply G. M. Lubriplate, G. M. Part Number 987785.

SPECIFICATIONS

SERIAL AND UNIT NUMBERS

Engine Number Stamped on the engine block behind and to left of the fuel pump.

Body Number Corvair and Spyder—Stamped on a plate attached to the left rear wheel well, within the engine compartment.
Corvair 95—Stamped on a plate attached to the front inner body panel, within the driver's compartment.

Serial Number Stamped on vehicle identification plate attached to the left lock pillar.

DIMENSIONS

Length:	
Corvair 95	179.7 in.
Corvair and Spyder	180.0 in.
Width:	
Corvair 95	70.0 in.
Corvair and Spyder	66.4 in.
Height:	
Corvair and Greenbrier	68.5 in.
Rampside	69.0 in.
Corvair and Spyder	51.3 in.
Wheel Base:	
Corvair 95	95.0 in.
Corvair and Spyder	108.0 in.
Turning Diameter:	
Corvair 95	42.6 ft.
Corvair and Spyder	39.0 ft.
Load Length—Corvair and Greenbrier	106.2 in.
Load Length—Rampside	103.3 in.
Load Width—Corvair and Greenbrier	59.4 in.
Load Width—Rampside	61.8 in.
Load Compartment Height—Corvair and Greenbrier	54.0 in.
Platform Height—Rampside	26.5 in.
Tailgate Width—Rampside	44.8 in.
Rampgate Width	47.5 in.

Side Loading Doors—Width	4.90 x 53.5 in.
Rear Loading Doors	36.0 x 44.6 in.

CAPACITIES

Gasoline Tank:	
Corvair 95	18.5 gal.
Corvair and Spyder	14.0 gal.
Crankcase Refill	4 qt.
Add for filter	1 pt.
Transmission:	
3-Speed	2 pt.
4-Speed	3 pt.
Differential	4½ pt.
Cooling System	Air Cooled Engine

ENGINE SPECIFICATIONS

Horsepower:	
Turbo-Air	80 @ 4400 rpm
Turbo-Air (Manza with Powerglide)	84 @ 4400 rpm
Super Turbo-Air	102 @ 4400 rpm
Turbocharged	150 @ 4400 rpm
Compression Ratio:	
Turbo-Air and Turbocharged	8.0:1
Turbo-Air (Manza with Powerglide)	9.0:1
Super Turbo-Air	9.0:1
Displacement	145 cu. in.
Bore and Stroke:	
Turbo-Air and Turbocharged	3.437" x 2.6"
Turbo-Air (Manza with Powerglide)	3.438" x 2.6"
Super Turbo-Air	3.438" x 2.6"
Firing Order	1-4-5-2-3-6
Spark Plugs (Gap .035"):	
Turbo-Air	AC-46-FF
Turbo-Air (Manza with Powerglide)	AC-44-FF
Super Turbo-Air and Turbocharged	AC-44-FF

Idle Speed:

Turbo-Air w/manual trans. (in Neutral)	450-500 rpm
Super Turbo-Air w/manual trans. (in Neutral)	600 rpm
Powerglide (In Drive)	450-500 rpm
Turbocharged (In Neutral)	825-850 rpm

Ignition Timing:

Turbo-Air (manual transmission)	4° BTDC
Super Turbo-Air and Powerglide	13° BTDC
Turbocharged	24° BTDC

Axle Ratios:

Engine	Transmission	Standard Ratio*	Optional Ratio
Turbo-Air	All	3.27:1	3.55:1-3.89:1
Super Turbo-Air	4-Speed	3.08:1	3.55:1-3.89:1
	Powerglide	3.55:1	3.89:1 —
Turbocharged	4-Speed	3.55:1	— —

*Standard Ratio: For Greenbrier and Air Condition Equipped Vehicles 3.55:1, for Rampside and Corvon 3.89:1.

BULB SPECIFICATIONS

	Candle Power	Number
Headlamp Unit (Sealed Beam)		
Outer—High Beam	37½ W	4002
Low Beam	50W	
Inner—High Beam Only	37½ W	4001
Parking Lamp-Directional Signal and Tail-Stop-Directional Signal Lamps	4-32	1034
Back-Up Lamps	32	1073
Instrument Lamps	3	GE 1816
Temp. Press., Gen. Fon., and Glove Compartment Lamps	2	57
Headlamp High Beam Indicator, Directional Signal Indicator, Ignition Lock, and Heater Control Panel Lamps	1	53
Dome Lamp	12	211
Courtesy Lamp	6	89
License Plate Lamp	4	67
Radio Dial Lamp	2	1891

FUSES AND CIRCUIT BREAKER

A circuit breaker in the light control switch protects the headlamp circuit, thus eliminating one fuse. Where current load is too heavy, the circuit breaker intermittently opens and closes, protecting the circuit until the cause is found and eliminated.

Fuses, located in the junction block beneath the dash are:

1. Heater Blower
Glove Compartment Lamp 3AG/AGC-10 amp.
 2. Tail and Stop Lamps,
Dome Lamp 3AG/AGC-10 amp.
 3. Heater (Total System)
Back-up Lamp 3AG/AGC-20 amp.
 4. Radio 3AG/AGC-4 amp.
 5. Instrument Panel Lamps
Radio Panel Lamp
Heater Control Panel Lamp 3AG/AGC-3 amp.
 6. Windshield Wiper Motor 3AG/AGC-20 amp.
- Air Conditioner Fuses 3AG/AGC-15 amp.
(Located in 14GA red and 12GA gray wires in area of ignition switch.)

SERVICE ACCESSORIES

Your Authorized Chevrolet Dealer carries a complete stock of Chevrolet Service Accessories, especially developed for use in keeping your Corvair, or any Chevrolet, looking like new for years to come. Many of these accessories are available for "do-it-yourself" work on your Corvair, or, if you desire, your Chevrolet Dealer has many cleaning and polishing services to offer.

EXTERIOR CAR CARE

All cleaners, polishes and tar removers in the following list have been especially compounded for use on Chevrolet Magic Mirror Acrylic Finishes.

*Porcelainize

Acri-Mel Polish and Cleaner—G. M. 985090

Triple Action Polish—G. M. 986085

Tar and Road Oil Remover—G. M. 987782

Chrome Polish—G. M. 986084

Chrome Gard—G. M. 987922

White Wall Tire Cleaner—G. M. 987475

Polishing Cloth—G. M. 987570

Touch-up Paint in Chevrolet Colors

*Undercoating

*—Dealer Applied.

INTERIOR CAR CARE

Use the following accessories to keep the interior of the car in new car condition.

Kar-Kleen Cleaner—G. M. 987611

Spot Remover—G. M. 987272

Leather Cleaner—G. M. 987646

MISCELLANEOUS

Designed to assure proper operation of various components of your Corvair, the following accessories will help to keep your car operating at peak efficiency.

Windshield Washer Anti-freeze and Solvent—
G. M. 988299

Doar Ease Stick Lubricant—G. M. 986897

Lock Ease Lubricant—G. M. 986434

Ruglyde Rubber Lubricant and Cleaner

Sealzit Glass Cleaner

Plastic Window Cleaner and Polisher—G. M. 985381

Penetrating Oil, Dripless—G. M. 988399

Lubriplate—G. M. 987785

MINOR TROUBLE SHOOTING GUIDE

	FUEL SYSTEM AND ENGINE								ELECTRICAL SYSTEM							COOLING SYSTEM					
	Check Fuel Gauge	Flooded Carburetor	Empty Carburetor Bowl	Poor Fuel Supply to Carburetor	Idle Adjustment*	Stuck Choke Valve*	Oil Level and Pressure	Condition of Air Cleaners	Malfunctioning Ignition Switch	Automatic Transmission Selector Lever	Check Spark	Battery and Connections	Generator and Voltage Regulator Connections	Coil and Distributor Leads	Starter Connections and Solenoid	Damp Electrical Connections	Generator Condition*	Air Flow Through Engine Restricted	Fan Belt Condition and Tension Adjustment	Cooling System*	Thorough Check and Tune-up Suggested*
On the following pages, see paragraph:	A	B	D	B-C-D	E	D	L	E	F	F	K	G	G	J	H	I	G	M	N	O	
See information on page number:	8						9-32	39		3-6		42					9				
CAR WILL NOT START:																					
Engine Will Turn Over	1	4		3							6			2			5				7
Engine Will Not Turn Over									2	1		3			4						
CAR WILL START—BUT:																					
Only After Repeated Tries										1											
Stalls in a Few Seconds			2	1	3																
Stalls When Hot					1	2		3													4
Idles Rough					1			2													3
Engine Overheats																		1	2	3	
"Dil" Indicator Comes On							1														
"Gen" Indicator Comes On												3	2				4		1		

*See Your Authorized Chevrolet Dealer

MINOR TROUBLE SHOOTING PROCEDURES

The chart on the previous page, and the information on the pages which follow, contains information designed to aid the average driver to discover, and possibly correct, conditions resulting in minor mechanical difficulties in his car. The chart, designed to point out possible solutions to several of the most common automotive malfunctions and point out a logical checking sequence, will lead step by step to the most likely causes and corrective procedures. If, after making the checks and adjustments suggested, the source of the trouble has not been found and corrected, it is strongly recommended that an Authorized Chevrolet Dealer inspect the vehicle and make whatever repairs or adjustments are necessary.

FUEL SYSTEM AND ENGINE

If the ignition switch will cause the engine to "turn over" or "crank" but the car will not start, check Steps A through D below.

NOTE: If continual "flooding" of the carburetor is evidenced by a carburetor wet with fuel or black exhaust smoke, perform the operation suggested in paragraph D only.

(A) The first and most obvious, and one of the most frequently overlooked, items to check when you have difficulty in starting your car is the amount of fuel in the tank. Make it a habit to check the FUEL GAUGE regularly and most especially at a time when the engine will "turn over" but will not start.



Checking Fuel Flow

(B) If the fuel tank is not empty,

you may check further to see whether the fuel is reaching the engine. Disconnect the fuel lines at the carburetor. Place a jar or cup under open line and briefly "crank" the engine by means of the starter. If fuel spurts from the line, you may assume that the FUEL LINES are clear and the FUEL PUMP is operating properly. If no fuel leaves the line, either the fuel lines or fuel pump are at fault. See your Authorized Chevrolet Dealer.

(C) Before reconnecting the fuel lines to the carburetor, remove the FUEL FILTER from carburetor inlet and check its condition. If it appears to be clean, replace it and reconnect the fuel lines. If the filter appears to be plugged, clean it as well as possible by scraping out the foreign material and cleaning in a solvent. Then reinstall the filter and repeat the procedure with the second carburetor. Replace the filters with new ones as soon as possible.

(D) If the fuel seems to be reaching the carburetors properly, the problem may be: an EMPTY CARBURETOR BOWL caused by a "stuck shut" float valve or a FLOODED CARBURETOR caused by a "stuck open" condition and evidenced by gasoline flowing down the outside of the carburetor; or a stuck CHOKE valve. Remove the air cleaners from the carburetors. Check that the choke valves move freely and are not stuck. Tap the side of the carburetors sharply several times with a light tool such as a screwdriver handle or pliers. Replace the air cleaners and attempt to start the engine in the normal manner.

(E) If the car will start but stalls when hot or has a rough idle, you can suspect a faulty IDLE ADJUSTMENT, or extremely dirty

and blocked AIR CLEANER ELEMENTS. Clean and reoil the air cleaner elements if necessary. Idle adjustment should be performed by your Chevrolet Dealer.

If the above Fuel System checks and the checks suggested under the Electrical System following do not correct the malfunction, it is recommended that you turn to your Authorized Chevrolet Dealer for further checks, adjustments or repairs.

ELECTRICAL SYSTEM

If, when the ignition key is turned to START, the engine will not turn over, you have good reason to suspect electrical trouble.

(F) When there is no response at all to attempts to start the car, check the obvious—your AUTOMATIC TRANSMISSION SELECTOR LEVER must be in neutral position before the engine can be started. Turning the IGNITION SWITCH rapidly back and forth several times will sometimes correct a poor internal switch contact.

(G) The BATTERY may be discharged. If so, lights will be dim and the horn will have a poor tone if it will blow at all.

Usually a garage recharge will be necessary to return the battery to operation. Occasionally, however, a push start and a long drive will recharge the battery.

NOTE: If the battery is determined to be dead, and for no apparent reason, have your Authorized Chevrolet Dealer check the battery, the GENERATOR and the VOLTAGE REGULATOR. GENERATOR trouble should already have been indicated by the generator indicator on the instrument panel.

POOR BATTERY CONNECTIONS may be suspected if the car has operated properly a short time before and now not even the horn will operate. Check both ends of both battery cables. If the connections are corroded, a car may sometimes be restored to operation by removing all cable ends, scraping off contacting surfaces clean with a pen knife, and reassembling. If the cables are broken, they must be replaced. The power supply should now be restored unless the battery is dead.

(H) If, however, the lights and horn work properly but the starter will still not turn over, check the STARTER connections. A "click" from the starter solenoid indicates that the wiring to the starter is properly installed. If the wiring seems to be clean and tightly installed, the trouble is probably in the starter itself and should be referred to your Authorized Chevrolet Dealer.

When the engine will "turn over" but will not start, the following items may be checked along with Fuel System Checks listed previously.

(I) With a clean dry cloth wipe the ceramic portions of the spark plugs dry. In particularly damp or rainy weather dampness may be the cause of not starting, especially when the engine is cold.

(J) Check the cables at the top of the distributor and coil as well as each spark plug cable for tightness.

(K) If the car will still not start, check for spark at the spark plugs in the following manner:

Pull one of the spark plug wires off its spark plug. Insert a short piece of bare wire (such as a bobby pin) between the rubber



Distributor and Coil Leads

cup at the end of the spark plug wire and the tubular metal connector inside of it. If the spark plug wire is wet or oily, wipe it dry. Wrap a dry handkerchief or facial tissue, folded several thicknesses, around the wire at least three inches back from the end and grasp wire at this point. Hold the bare wire about $\frac{1}{4}$ inch from the bare tip of the spark plug from which you removed the wire. When the engine is "turned over" a spark should jump across the $\frac{1}{4}$ inch space, indicating ample current supply. If no spark jumps, the difficulty is probably caused by a defective ignition part and should be corrected by your Authorized Chevrolet Dealer.

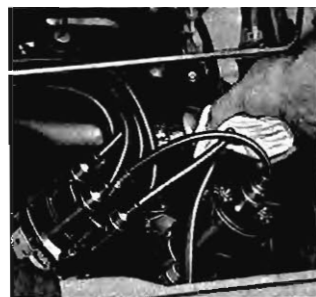

Checking for Spark

COOLING SYSTEM

When the car will run but evidences serious overheating on the temperature gauge in the instrument panel, there are several items which may be checked.

(L) Engine overheating will occur when the OIL LEVEL falls dangerously low. Check the oil level as a matter of course.

CAUTION: Never drive the car when the TEMP-PRESS indicator in the instrument panel is lighted. (See Page 9.)

(M) Check the air intake louvers. Clean them if they are plugged with leaves or other foreign material.

(N) Condition of the FAN BELT is very important, not only for engine cooling but also for proper generator operation. Check the condition of the belt. Replace it if it is worn or frayed. Loosen the idler bracket bolts and move the bracket toward the engine to remove and replace the belt. Tighten the belt, whether new or old, by loosening the idler bracket nuts, prying with a bar on the bracket until the belt is tensioned properly, then retighten the bracket bolts. Proper belt tension is such that, when belt is deflected downward with moderate thumb pressure at a point midway between the generator and fan pulleys, the belt will deflect about $\frac{3}{8}$ " to $\frac{7}{16}$ ". Do not overtighten the belt.



Checking Fan Belt Tension

(O) Another cause of engine overheating may be an inoperative COOLING SYSTEM THERMOSTAT. If the thermostat should fail in the closed position, it will not permit air to circulate through the engine. See your Authorized Chevrolet Dealer.

INDEX

	Page	Page	
Air Cleaner	39	Cylinder Head Temperature Gauge	23
Air Conditioning	15 & 40	Dimmer Switch	11
Air Recirculating Plates	22	Distributor	39
Air Vents	17	Doors and Locks	18 & 26
Ash Tray	17 & 26	Rear	19 & 27
Battery	33 & 35	Side	27
Body Lubrication	43	Driving for Economy	2
Brake Main Cylinder	43	Engine Oil Cooler	40
Brake—Parking	12	Engine Compartment	21 & 26
Brakes	22	Engine Lubrication	32
Bright Metal Parts		Front Suspension	38
Protection	30	Front Wheel Bearings	40
Type and Location	31	Fuel Filter	42
Chassis Lubrication	38	Fuel Gauge	8
Cigarette Lighter	17	Fuses	45
Circuit Breaker	41	Gas Cap	21 & 29
Cleaning Hints		Generator	39
Exterior Appearance	24	Gen-Fan Indicator	9 & 23
Interior Appearance	25	Heater	
Clutch Cross Shaft Lever	38	Direct Air	14
Clutch Pedal	12	Gasoline	14
Clutch Pulleys & Cables	43	Ignition Switch	3
Cooling System	33	Jacking the Car	36
Crankcase Ventilation Valve	37	Keys	18
		Light Control Knob	10
		Lighting System Trouble Checks	11

	Page
Luggage Compartment	21
Maintenance and Lubrication (Periodic)	37
Manifold Pressure Gauge	23
Octane Requirements	32
Oil Filter	37
Parking Brake	
Operation	12
Service	43
Polishing Your Corvair	30
Positraction Axle	7
Pushing to Start	
Manual Transmission	5
Powerglide	7
Radios	16-17
Rampside	28
Rear Axle	35 & 42
Rocking Car—Powerglide	7
Seats	19 & 28
Front Seat Adjustment	19 & 28
Rear Seat—Folding	20
Second Seat	29
Service Accessories	46
Service Brakes	12
Serial and Unit Numbers	44
Spare Tire	35
Specifications	44 & 45

	Page
Speedometer	8 & 23
Starting the Engine	3
Steering Linkage	38
Steering Gear	37
Switching Tires	19
Tachometer	23
Tailgate	28
Temp-Press Indicator	9 & 23
Tire Care	34
Towing—Powerglide	7
Transmission	
Manual	
Operation	4-5
Service	41
Powerglide	
Operation	5-7
Service	41
Trouble Shooting Guide	47
Trouble Checks	
Lighting System	11
Turn Signal	11
Universal Joints	40
Warm-up	4
Washing Your Corvair	30
White Sidewall Tires	31
Windshield Wipers and Washers	13 & 25

— NOTES —

— NOTES —

CHEVROLET OWNER PROTECTION PLAN

The Chevrolet Motor Division considers it a most important obligation to offer each owner a suggested maintenance service which will relieve him of any anxiety and insure that his vehicle is regularly inspected and maintained.

Your Chevrolet dealer has presented you with a Chevrolet Owner Protection Plan Booklet. The Approved Maintenance and Lubrication Service items in this booklet have been worked out by Chevrolet service personnel and cover items which are the owner's responsibility to have checked, inspected, adjusted and lubricated at recommended mileage intervals. All maintenance operations which are necessary at the varying mileages on a vehicle operating under normal conditions are included.

If the services are carried out at the prescribed mileage intervals, wear and owner expense will be kept to a minimum. Further services may become necessary as mileage accrues, however, the regular visit that you make to your Chevrolet dealer in following this Plan will point out desirable services as they become necessary.